



EpilogLaser

MINI 18/24 & HELIX

Laser System Manual | Model 8000



Register your system now for driver updates and access to our Training Suite!
TRAINING.EPILOGLASER.COM/REGISTER

Technical Support: +1 (303) 215-9171
Knowledge Base: support.epiloglaser.com
System Registration: training.epiloglaser.com/register
Driver/Firmware: epiloglaser.com/legend-drivers

TABLE OF CONTENTS

Fire Warning	1
Introduction	2
How to Use This Owner's Manual.....	2
Icons Used in this Manual.....	2
Section 1: Safety	3
Laser Safety	3
Electrical Safety.....	4
Fire Warning.....	5
Safety Features and Regulatory Compliance	6
Do's and Don'ts.....	9
Section 2: Getting Started	11
1. Unpacking the Laser System.....	11
2. Choose Where to Locate the System.....	12
3. Connecting the Exhaust.....	12
4. Connecting Electrical Power.....	14
5. Connect the Laser to Your Computer	15
6. Set the Mini/Helix IP Address.....	15
7. Sign Up for Driver Updates and Register Your System	16
Section 3: Driver Installation	19
Windows 7: Ethernet Installation.....	19
Windows 7: USB Installation	23
Windows 8 and 10: Ethernet Installation.....	26
Windows 8 and 10: USB Installation	30
Section 4: The Epilog Job Manager	35
Epilog Job Manager Instructions.....	35
How to Install the Epilog Job Manager.....	35
Trouble Shooting Job Manager Installation.....	37
Important Epilog Job Manager Notes.....	38
Using the Epilog Job Manager	38
Section 5: Using The Laser Dashboard™	45
Changing Laser Dashboard Defaults	45
General Tab	46
Advanced Tab.....	49
Color Mapping Tab.....	51
Additional CorelDRAW Laser Dashboard Features	52
Section 6: Mini/Helix Control Panel	53
Display	53
Button Functions	54
Job Storage: Temporary Memory.....	59
Section 7: Quick Start Guide	61
First Test Job.....	61
Artwork Setup	61
Setting a Vector Cutting Line.....	63
Landscape or Portrait.....	66

TABLE OF CONTENTS

Piece and Page Size	67
Section 8: Cleaning & Maintenance	69
Reduce Fire Risk with a Clean Laser	69
Cleaning the Auto Focus Plunger	69
Cleaning the Optics	69
Cleaning the Optical Strip and Encoder	70
Cleaning and Lubricating the Bearing Rails	71
Crumb Tray Cleaning	73
Exhaust Cleaning	73
Section 9: System Features	75
Air Assist	75
Auto Focus vs. Manual Focus	75
Image Dithering	77
Color Mapping	78
Reset Home Position	83
Red Dot Pointer	83
Movable Home Position	84
Center Engraving	85
Front Access Door	87
Task Plate	87
Vector Cutting Table	88
Changing the Table	88
Vacuum Hold-Down Table	89
Integrated Crumb Tray	89
Section 10: Optional Features	91
Pin Table	91
Rim-Drive Rotary Attachment	94
Optional Lens Assemblies	100
PhotoLaser Plus	101
Section 11: Upgrading the Operational Firmware	109
How to Upgrade Your Firmware	109
Section 12: Printing From AutoCAD	111
How to Print from AutoCAD to the Laser	111
Section 13: Material Engraving Techniques	113
Laser Materials/Techniques	113
3D Engraving	113
Acrylic	114
Anodized Aluminum	115
Brass - Painted	116
Glass	117
Notary Seals: Delrin	118
Plastic Engraving/Cutting	119
Rubber Stamps	120
Wood	124

TABLE OF CONTENTS

Section 14: Specifications	129
Epilog Mini / Helix Laser Technical Specifications	129
Compatibility	130
Recommended PC.....	130
About The CO2 Laser Source	131
Federal Communications Commission (FCC) Notice	132
Section 15: Technical Support	133
Contacting Technical Support.....	133
Frequently Asked Questions	134
Section 16: Material Suppliers	137
Industry Material Supplier List	137
Appendix A: Warranty Statement	141
Warranty Statement for the Epilog Mini/Helix Laser	141
Appendix B: Material Settings	143
Epilog Mini / Helix Suggested Material Settings	143
Index	147

FIRE WARNING



Fire Warning

Your laser system uses a high intensity beam of light that can generate extremely high temperatures when it comes into contact with the material being engraved, marked or cut. Some materials are extremely flammable and can easily ignite and burst into open flame setting the machine afire. This open flame is very dangerous and has the potential to destroy not only the machine, but the building in which it is housed.

Experience shows that vector cutting with the laser has the most potential to create an open flame. Many materials are susceptible to igniting, but acrylic, in all its different forms, has been shown to be especially flammable when vector cutting with the laser.

Please read the following warnings and recommendations and follow them closely at all times!

- **Stay with the laser.** Never operate the laser system while unattended.
- **Keep the area clear.** Clean around the machine and keep the area free of clutter, combustible materials, explosives, or volatile solvents such as acetone, alcohol, or gasoline.
- **Be prepared with a fire extinguisher.** Always keep a properly maintained and inspected fire extinguisher on hand. Epilog recommends a Halotron fire extinguisher or a multi-purpose dry chemical fire extinguisher. The Halotron extinguishers are more expensive than a dry chemical, but offer certain advantages should you ever need to use an extinguisher. The Halotron extinguisher discharges a clean, easily removable substance that is not harmful to the mechanics or wiring of the laser system. The dry chemical extinguisher discharges a sticky, corrosive powder that is very difficult to clean up.
- **Use Air Assist.** Always use the system's Air Assist feature when vector cutting.
- **Use caution when vector cutting.** Many materials have the potential to suddenly burst into flames when cut with a laser – even materials that may be very familiar to the user. Always monitor the machine when it is operating.
- **Clean the laser.** A buildup of cutting and engraving residue and debris is dangerous and can create a fire hazard in its own right. Keep your laser system clean and free of debris. Regularly remove the Vector Cutting Table to clean any small pieces that have fallen through the grid.

How to Use This Owner's Manual

Thank you for purchasing an Epilog Mini or Helix Laser system. Your Epilog system has been designed to be easy to operate, but you will utilize it to its fullest potential by taking some time to read this owner's manual prior to use. You will be ready to use the Epilog Laser system as soon as you read the first few sections. Then you can refer to topics in the remaining sections, as you work.

Icons Used in this Manual

Look for these symbols to help you find valuable information throughout the text:



Helpful notes to keep in mind when running the laser!



This icon signifies advice you can try that will save you significant time.



This icon highlights current contact information for receiving help.



Warnings and cautions to keep in mind when running the laser.



This icon indicates the potential for fire damage when operating the laser.

SECTION 1: SAFETY

Laser Safety

The Epilog Model 8000 Laser System is a Class 2 laser product, as defined in International Standard IEC 60825-1.

The Epilog Model 8000 complies with 21 CFR 1040.10 and 1040.11, the Federal Performance Standards for Light-Emitting Products, except for deviations pursuant to Laser Notice No. 50, dated July 16, 2001. The Center for Devices and Radiological Health, of the US FDA, issued Laser Notice No. 50 to permit manufacturers to classify and manufacture their products in accordance with the International Standard.

The output of the embedded high-power CO2 engraving laser is fully contained. The laser cabinet has safety interlocks that turn the laser off if the door is opened during operation, and no special precautions are necessary to operate the high-power laser safely. However, the visible output beam of the Laser Diode Pointer (Red Dot Pointer) is accessible to the operator. While this device employs the same technology as the familiar laser pen-pointers, like them it is potentially hazardous if its beam is directed into the eye.

We have made every effort to make the Laser Diode Pointer (Red Dot Pointer) as safe as possible. Its beam path is located well inside the cabinet, and under normal conditions, no hazardous levels of laser radiation can escape.

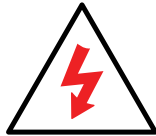

The operator of the Epilog Model 8000 should observe the following general precautions:

- **DO NOT** disassemble the machine or remove any of its protective covers while the unit is plugged in.
- **DO NOT** attempt to defeat the door interlocks.
- **DO NOT** view directly into the beam of the Laser Diode Pointer (Red Dot Pointer).
- **DO NOT** operate the Laser Diode Pointer (Red Dot Pointer) without the machine's focus lens in place. If the unfocused beam strikes a reflective surface, it could be directed out of the cabinet.
- **Caution** – Use of controls or adjustments or performance of procedures other than those specified herein may result in hazardous radiation exposure.

The standard reference for laser safety is the American Standard for the Safe Use of Lasers, Z136.1-2000, developed by the American National Standards Institute (ANSI). This reference is the basis for many of the federal regulations for laser and laser system manufacturers, and for the Occupational Safety and Health Administration (OSHA) laser safety guidelines. It contains detailed information concerning proper installation and use of laser systems.

While the ANSI standard itself does not have the force of law, its recommendations, including warning signage, training, and the designation of a laser safety officer, may be compulsory under local workplace regulations when operating laser systems above Class I. It is the operator's responsibility to ensure that the installation and operation of the Epilog Model 8000 Laser System is performed in accordance with all applicable laws.

Copies of ANSI Standard Z136.1-2000 are available from Epilog Corporation or from:



Laser Institute of America
12424 Research Parkway, Suite 125
Orlando, FL 32826
(407) 380-1553

Electrical Safety

The AC input power to the Epilog Model 8000 Laser System is potentially lethal and is fully contained within the cabinet.

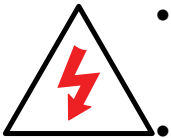

- **DO NOT** open any of the machine's access panels while the unit is plugged in. Opening a panel may expose the operator to the unit's AC input power.
- **DO NOT** make or break any electrical connections to the system while the unit is turned on.



Fire Warning

Didn't you see this already? Yes! That's how important we think it is for you to read this information.

Your laser system uses a high intensity beam of light that can generate extremely high temperatures when it comes into contact with the material being engraved, marked or cut. Some materials are extremely flammable and can easily ignite and burst into open flame setting the machine afire. This open flame is very dangerous and has the potential to destroy not only the machine, but the building in which it is housed.

Experience shows that vector cutting with the laser has the most potential to create an open flame. Many materials are susceptible to igniting, but acrylic, in all its different forms, has been shown to be especially flammable when vector cutting with the laser.

Please read the following warnings and recommendations and follow them closely at all times!

- **Stay with the laser.** Never operate the laser system while unattended.
- **Keep the area clear.** Clean around the machine and keep the area free of clutter, combustible materials, explosives, or volatile solvents such as acetone, alcohol, or gasoline.
- **Be prepared with a fire extinguisher.** Always keep a properly maintained and inspected fire extinguisher on hand. Epilog recommends a Halotron fire extinguisher or a multi-purpose dry chemical fire extinguisher. The Halotron extinguishers are more expensive than a dry chemical, but offer certain advantages should you ever need to use an extinguisher. The Halotron extinguisher discharges a clean, easily removable substance that is not harmful to the mechanics or wiring of the laser system. The dry chemical extinguisher discharges a sticky, corrosive powder that is very difficult to clean up.
- **Use Air Assist.** Always use the system's Air Assist feature when vector cutting.
- **Use caution when vector cutting.** Many materials have the potential to suddenly burst into flames when cut with a laser – even materials that may be very familiar to the user. Always monitor the machine when it is operating.
- **Clean the laser.** A buildup of cutting and engraving residue and debris is dangerous and can create a fire hazard in its own right. Keep your laser system clean and free of debris. Regularly remove the Vector Cutting Table to clean any small pieces that have fallen through the grid.

Safety Features and Regulatory Compliance

Epilog has incorporated specific safety features into the Model 8000 Laser System in order to meet the requirements of 21 CFR 1040 and the International Standard IEC 60825-1. These safety features include:

- A safety enclosure (cabinet), which fully encloses the engraving laser and its beam path.
- Dual redundant interlock systems that turn off the engraving laser when the window is opened.
- A visible emission indication when the Laser Diode Pointer (Red Dot Pointer) is operating. There is an LED indicator on the machine's front panel.

21 CFR 1040 and IEC 60825-1 require that certification, identification, and warning labels be placed on laser products. Reproductions of labels on the Epilog Model 8000 Laser System follow, with their locations specified:

1. **Certification/Identification Plate:** This engraved plate is located on the left rear of the machine's cabinet.

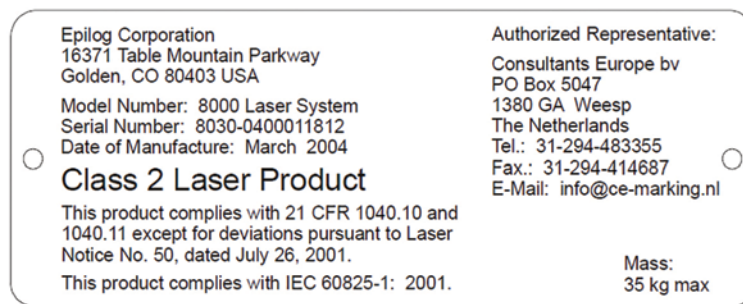

2. **Warning Logotype:** This label is located on the left rear of the machine's cabinet, below the Certification/Identification plate.



SECTION 1: SAFETY

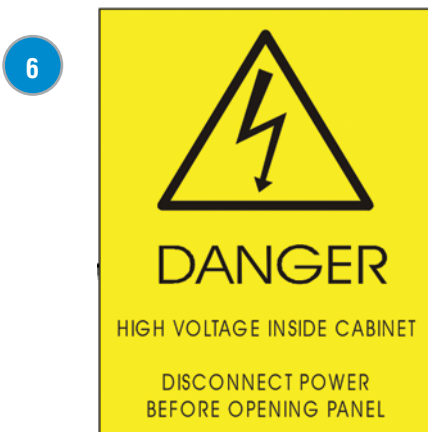

- 3. Descriptive Label:** This label identifies the classification of the Model 8000 in accordance with 21 CFR 1040.10 and IEC 60825-1. It is located on the rear of the machine's cabinet, beside the Warning Logotype.
- 4. Non-interlocked Protective Housing Safety Labels (4):** Two of these labels are located on the rear of the machine beside the edges of each of the cabinet's end covers. The other two are located on the cabinet walls under the cover so they are visible when the covers have been removed.
- 5. Defeatably-interlocked Protective Housing Safety Labels:** This label is located on the machine's cabinet door, in the upper left hand corner.
- 6. Electrical Safety Label:** This label is located on the access panel on the rear of the machine's cabinet.
- 7. Fire Safety Label:** This label is located on the machine's cabinet door in the upper right hand corner.
- 8. Aperture Safety Label:** This label is located on the steering mirror cover inside the machine's cabinet, beside the aperture where the laser beams enter the cabinet.
- 9. Fire Warning Label:** There are two labels on top of the machine's cabinet; one to the left and one to the right of the top cabinet door.



Supplier's Declaration of Conformity 47 CFR Paragraph 2.1077 Compliance Information

Laser Materials Processing System Model 8000

Epilog Laser Corporation
16371 Table Mountain Parkway
Golden, CO 80403

Telephone: (303) 277-1188

This device complies with Part 15 of the FCC Rules. Operation is subject to the following two conditions:

- (1) This device may not cause harmful interference, and
- (2) This device must accept any interference received, including interference that may cause undesired operation..

NOTE: This equipment has been tested and found to comply with the limits for a Class A digital device, pursuant to Part 15 of the FCC Rules. These limits are designed to provide reasonable protection against harmful interference when the equipment is operated in a commercial environment. This equipment generates, uses, and can radiate radio frequency energy and, if not installed and used in accordance with the instruction manual, may cause harmful interference to radio communications. Operation of this equipment in a residential area is likely to cause harmful interference in which case the user will be required to correct the interference at his own expense.

Do's and Don'ts



Don'ts

Do Not Run the Laser Unvented: Never operate the machine without a properly operating vent to the outside or to a filtration unit! Most material will only produce an irritating smoke when engraved. Some materials, including but not limited to paint, varnish, composition board and plastics, produce compounds that can be harmful if concentrated. A properly installed vent is the only way to ensure that problems do not occur.

Do Not Engrave or Cut PVC: Never engrave or cut **any material** containing PVC or vinyl. When engraved, a corrosive agent is produced that will destroy your machine. Your warranty will be void if your machine is damaged by corrosion from engraving or cutting PVC or Vinyl.

Do Not Operate Machine While Unattended: Never operate your machine without someone watching the system. There is a significant risk of fire if the machine is set improperly, or if the machine should experience a mechanical or electrical failure while operating.

Do Not Vector Cut While Machine is Unattended: Never laser cut any material with the laser without someone watching the system. Because vector cutting moves relatively slowly compared to raster engraving, a tremendous amount of heat is applied to the material being cut. This buildup of heat can cause significant fire risk and the machine should always be monitored. Additionally, the Air Assist should always be turned on when vector cutting to reduce the risk of fire.

Do Not Operate The System While Doors are Open: Never operate with any of the covers or enclosures removed, and never modify the enclosure. The laser beam is invisible and is very dangerous!



Do's

Clean the System: Please allow a few minutes a week for cleaning your machine. Just a small amount of effort at the end of the week will pay off with years of trouble free operation of your machine.

See the “**Section : Cleaning & Maintenance**” on page 69 for specifics.

SECTION 2: GETTING STARTED

1. Unpacking the Laser System

Setting up your Epilog Laser System is easy to do! If you've ever installed a paper printer, this is only slightly more difficult. The following information will help you understand the entire system and how it works.

Your laser system consists of the following components:

1. Mini 18/24 or Helix Laser System
2. Epilog Driver Disc
3. USB and Ethernet Cables

You will also need:

1. A computer or laptop.
2. An exhaust fan: The exhaust fan is mandatory and is used to remove smoke and debris from the laser's work area. The exhaust air can be ported to the outside or into a filter box.

Follow these steps to setup your Mini or Helix Laser system:

1. Unpack the laser system.
2. Choose where to locate the system.
3. Connect the exhaust system to your laser.
4. Connect the electrical power.
5. Connect the laser to your computer through USB or Ethernet.
6. Sign up for driver update and register your system at www.epiloglaser.com/register.

1. Unpacking the Laser System



Unpack the laser system from the crate provided by Epilog. **Please be sure to hold on to all packing materials and crating in case you need to move the system in the future.**

2. Choose Where to Locate the System

Cooling Requirements and Operating Temperatures

All Epilog Laser systems use air-cooled laser tubes. Laser technology is such that the laser tubes generate a lot of excess heat and the tubes must be cooled for proper operation. There are cooling fans located at the back of the laser. The fans and vents should always be clear of restrictions and should never be covered. Use compressed air to remove any dust buildup on the fans or laser cooling fins.



Warning: The cooling fans and vents are located on top and back of the Mini and Helix and should never be covered or blocked in any way. Lasers that overheat will not operate properly and may begin to produce erratic laser output or possibly complete failure.

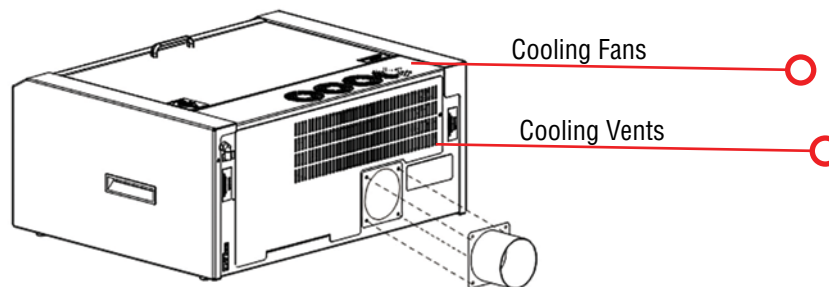

Ambient air temperature where the laser system is operating should not exceed 90 degrees F (32 C). Operating in an environment where the ambient air temperature is above 90 degrees F (32 C) will void the Epilog warranty.

3. Connecting the Exhaust

In this manual, the term “exhaust” refers to either an exhaust fan or a filter unit and the term “exhaust” is used for simplicity. The important point is that it is mandatory that an exhaust unit or filter system is incorporated as part of your laser system. Never operate your laser system without a properly functioning exhaust. The exhaust removes the dust, debris and smell from the engraving cavity and exhausts it to the outside of the building or to the filter unit. Prior to the installation of the laser system, you may need a contractor to install the exhaust system. The blower should be mounted outside your building for noise considerations. Ideally, the blower should not be more than twenty feet (6 meters) from the laser. You should provide a metal duct (flexible aluminum or galvanized sheet metal) from the blower to the laser. All

SECTION 2: GETTING STARTED

3. Connecting the Exhaust

Epilog model 8000 laser systems require an exhaust fan that is rated at a minimum of 350 CFM for an external exhaust.

Epilog provides recommended exhaust flow rates (CFM) only for direct ventilation exhaust systems that are ported to the outside. Please note that this is also a recommendation and not a requirement because factors such as length and type of tubing from the Epilog laser to the exhaust fan and from the exhaust fan to the outside of the building can produce significant losses on the true amount of air that is drawn from the Epilog laser.

Exhaust flow rates (CFM) for filter systems are not specified in this document. However, exhaust flow rates for filtration units will be lower than a direct ventilation exhaust systems because filters are designed to be placed directly adjacent to the laser system and do not exhibit the air-flow losses that are typically found with direct exhaust fans. Epilog has worked with most major filter manufacturers to recommend a specific filter system for each model of Epilog laser. Please contact your Epilog distributor to match a filter to the Epilog laser system you are using.



Note: Remember to put the blower switch for the laser system in an obvious and accessible place so it can be routinely switched on prior to using the engraver. Please connect the exhaust blower to the laser as shown below and on the following pages. Remember, you may need a contractor to install the exhaust. This must be done PRIOR to installation of the laser system.



Warning: It's important that either rigid or flexible metal ducting be used for all connections leading to and from the laser system and the exhaust fan. Vinyl, plastic, or any type of "soft" ducting is potentially flammable and should not be used unless provided by the filtration system manufacturer and made from fire-proof materials.



Epilog Exhaust/Filter Connections

As part of the unpacking process you will find a 4" (100mm) exhaust port in the accessories kit. This part needs to be attached to the rear of the system chassis before connecting the Exhaust blower to the system.

The mounting screws for the exhaust port are in the mounting holes in the chassis. Remove these four screws, align the exhaust port to the mounting holes and secure the exhaust port with the four screws. There is one 4" (102 mm) port attached to the back of the laser system. Attach your ducting to the machine as shown in the diagram.

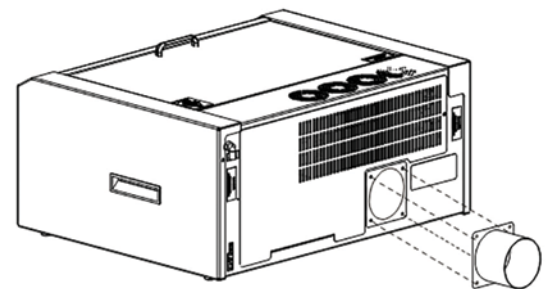

Once the exhaust ports are installed on the back of the laser system, use the flexible aluminum or galvanized sheet metal ducting to connect the laser system to the intake side of the exhaust fan. Then connect the exhaust side of the exhaust fan to the metal duct leading outside.

SECTION 2: GETTING STARTED

4. Connecting Electrical Power



Check your exhaust system for leaks. Most small leaks can be remedied with duct tape. **DO NOT OPERATE** your laser with inadequate or leaking exhaust.

The drawings show the typical exhaust setup. The left drawing shows the exhaust near the machine and the right drawing shows the exhaust fan on the roof. Where the exhaust fan is placed is a choice of personal preference. Some users like the exhaust fan outside because of noise considerations.

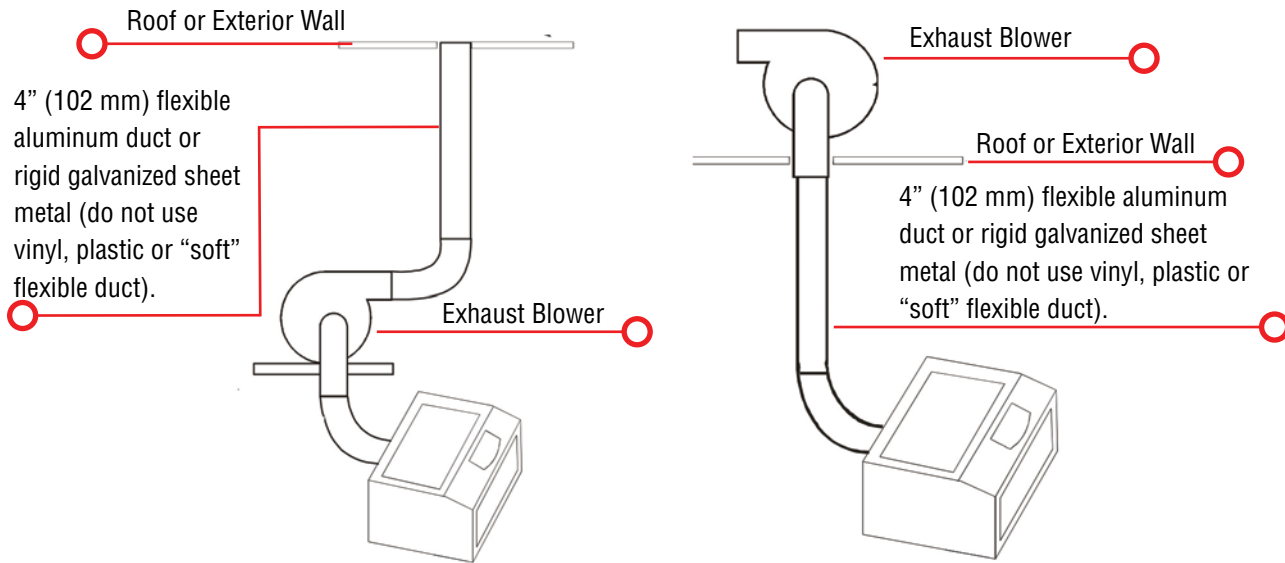

4. Connecting Electrical Power

All Epilog Laser systems have an auto-switching power supply that detects the incoming voltage and automatically switches itself to operate properly at any single-phase voltage between 110 and 240 VAC. The power supply will also automatically compensate for either 50 or 60 Hz. Epilog supplies the appropriate power cord for all of our equipment. The electrical cord is found in the accessory package with your machine. It is recommended that a dedicated 15 amp circuit be used if available, but it is not required.

The 60 and 80 watt machines draw more current than the lower wattage lasers. These systems can operate on 110 volts, but most users find that a 220 V connection is more efficient. The electrical connection is found at the lower left side of the machine.



SECTION 2: GETTING STARTED

5. Connect the Laser to Your Computer

5. Connect the Laser to Your Computer

You can choose to connect your laser to your computer with either an Ethernet cable or a USB cable. For your convenience Epilog includes both an Ethernet crossover cable and a USB cable in the Accessories kit.



Choose one or the other, but do not plug both cables into the laser at the same time.

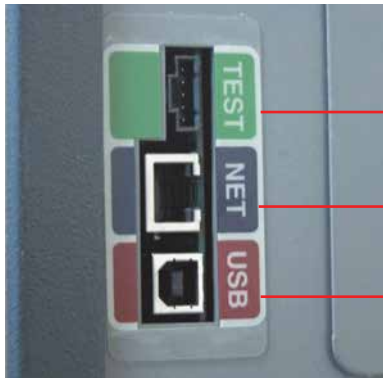

Test Port: Not intended for consumer use.

Ethernet Port

USB Port

USB Connection

A USB cable is included in the accessory kit. The USB port is located on the right side of the laser, at the rear of the system. USB cables have different connectors on each end. **Before plugging in the USB cable, turn the laser OFF**, then connect one end to the laser and connect the other end into any available USB port on your computer. **After** connecting the USB cable, turn the laser back on.

Your computer will recognize a new USB device and walk you through the print driver installation. See **“Windows 8 and 10: USB Installation”** on page 13.

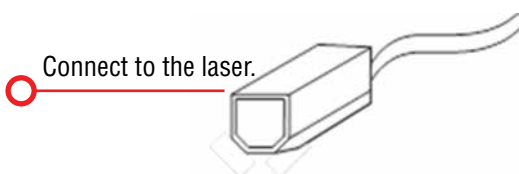

If your laser will be a long distance from your computer, you will see better performance using the Ethernet cable.

Ethernet Connection

The Ethernet Port is a standard 10BaseT connection. Your Epilog Laser has all of the versatility of a network capable peripheral. As such, there are many different ways that the laser can be connected to a computer or a network. A direct connection using a crossover cable is the only method that will be described in this manual. Connect the crossover cable (included in the accessories kit) to the Ethernet port, located on the right side of the machine near the rear. Plug the cable into the Ethernet port on the laser, then plug the other end into the Ethernet port on your computer.

The Epilog Dashboard is the print driver that allows your computer to talk to your Epilog Laser system when either the USB or Ethernet Crossover cables are connected. The driver is included in the accessories kit on a CD-ROM or on our website at www.epiloglaser.com. To install the print driver, see **“Windows 8 and 10: Ethernet Installation”** on page 13.

6. Set the Mini/Helix IP Address



1. To set the IP Address, press the **Go and Pointer keys on the control panel at the same time**. You will see **FUNCTIONS MENU** displayed on the control panel LCD screen.
2. Press the **Go** key. **SERIAL #** will appear on the screen. This is a factory set number and corresponds to the serial number of the laser system. You should not change this number.

SECTION 2: GETTING STARTED

7. Sign Up for Driver Updates and Register Your System

3. Press the **Go** key again. **IP ADDRESS** will appear on the screen.
4. Press the **Go** key again. The factory set IP address will appear on the screen. It will look similar to **192.168.003.004** with a flashing box over the 1 in 192.



Most Epilog users will use the IP Address of 192.168.003.004, which is what we use in this manual.

5. If you want to change the IP address, follow these instructions:
 - The numbers are treated as groups of three. If you want to change the first number to 4, press the corresponding number on the keypad (the Power key).
 - Repeat for the second and third numbers in the group.
 - After changing the third number in the group, the flashing cursor will move back to the first number. Press **Go** to move to the next group of numbers.
 - Repeat this for each of the four groups of three numbers.
 - You cannot skip to change a single number in a group of three - all three must be typed in to change that group. For example if you want to change 003 to 004, you must press all three numbers to change that grouping.
 - To save your new IP Address, continue to click **Go** through the Subnet Mask and Gateway settings until you see **Save-GO No-Stop**. Press **Go** to save your changes (or pause/stop to not save your changes.)

7. Sign Up for Driver Updates and Register Your System

Go to www.epiloglaser.com/register and register your system. You can also sign up for our monthly e-newsletter, quarterly customer printed newsletter, and sign up for driver update notifications.

SECTION 3: DRIVER INSTALLATION

Windows 7: Ethernet Installation

Next we'll be installing the print driver. Choose your operating system. We demonstrate Windows 7, 8, and 10 installations.

Windows 7: Ethernet Installation

Set Up TCP/IP Address in the Computer

1. Go to your **Network and Sharing Center** in your computer's **Control Panel**.

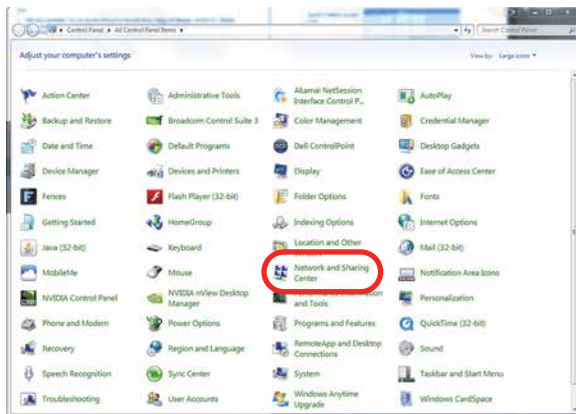

2. Click **Change Adapter Settings**.

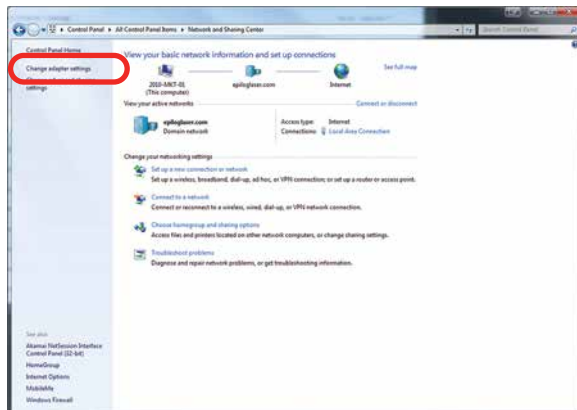

3. Right click **Local Area Connection**, then click **Properties**.

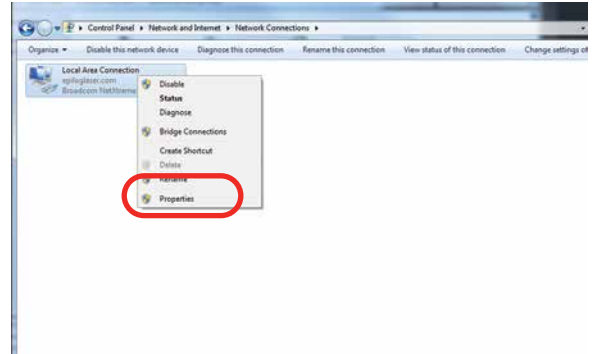

4. Select **Internet Protocol Version 4 (TCP/IP)**. Make sure you do not select Version 6.

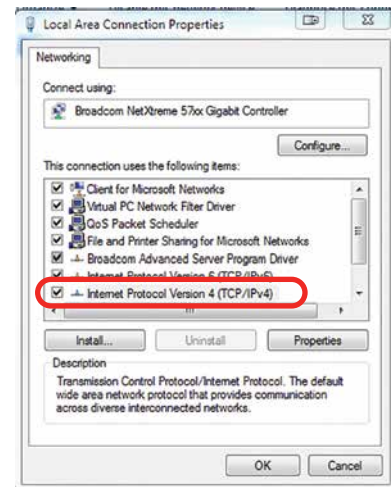

5. Select **Use the following IP Address**. Type in the following IP Address: **192.168.3.3**.



This number is not an error; the last digit of the IP address in **this window must be different than the IP address you set in the laser.**

SECTION 3: DRIVER INSTALLATION

6. Type in a Subnet Mask of **255.255.255.0**, then click **OK**.

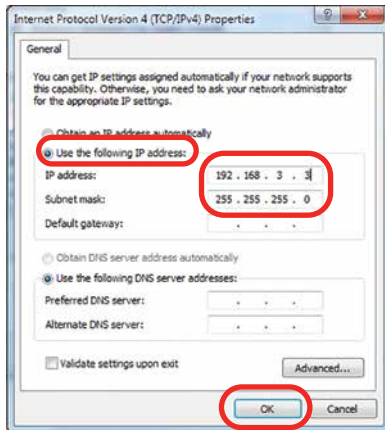

Installing the Driver

1. Insert the Driver CD in the computer and select your laser system.



2. Select the Dashboard Driver.



You can also download the latest driver from epiloglaser.com/tech-support/epilog-drivers.htm. Go to **Devices and Printers** on your computer and click **Add a Printer** to start the process.

3. Click **Add a local printer**.

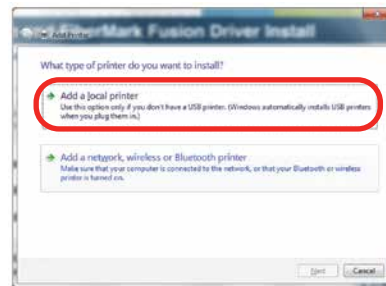

4. Click **Create New Port**, then click on the drop-down menu and select **Standard TCP/IP Port**, then click **Next**.

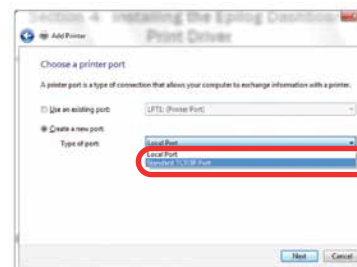

5. Enter the IP Address to match the IP Address you set at the laser in "**Setting the IP Address**" on page 15. Most Epilog users will use the IP Address of 192.168.3.4, which is what we use in this document. After typing in the IP Address, click **Next**. Wait while the computer identifies the port.

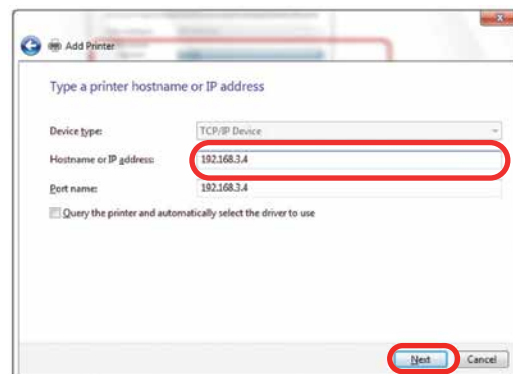

SECTION 3: DRIVER INSTALLATION

6. Select **Custom** and then **Settings**.

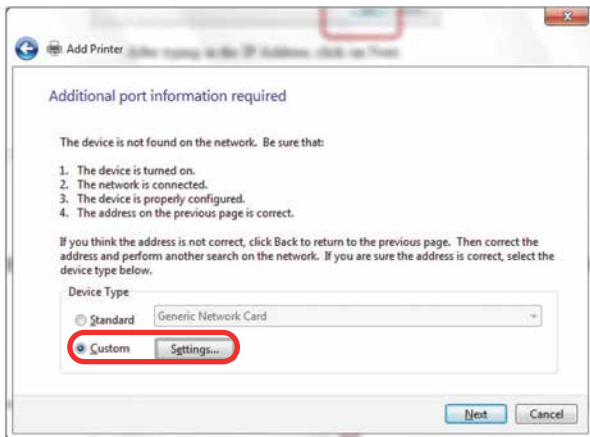

7. **Set Protocol to LPR.** This is a very important step. Your download time will increase significantly if LPR is not selected. Type **Legend** into the Queue Name, then click **OK**.

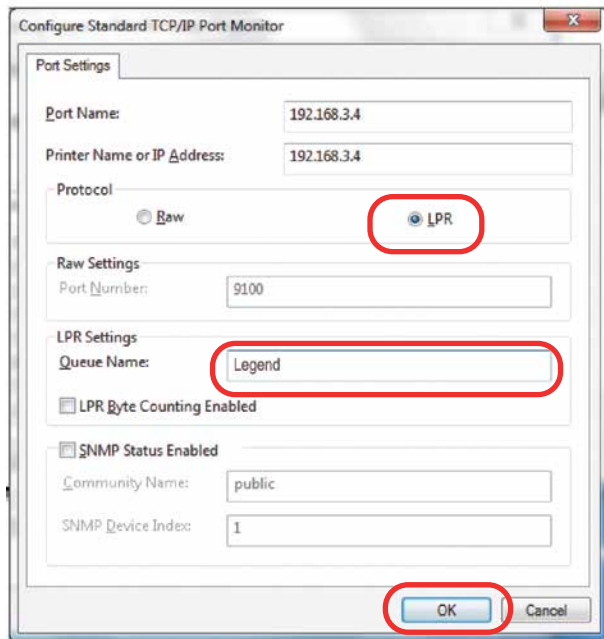

8. Click **Next**.

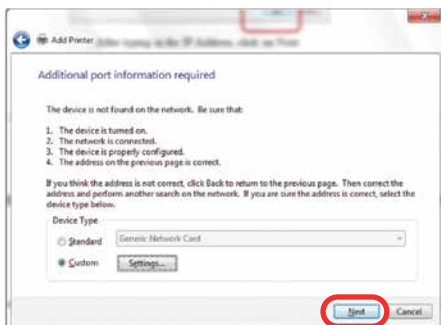

9. Click **Have Disk**.

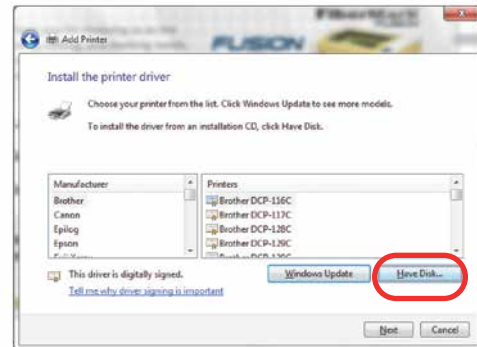

10. Click **Browse** and go to the folder where you saved the driver and click **Open**. (The default location is c:/minihelix_driver.)

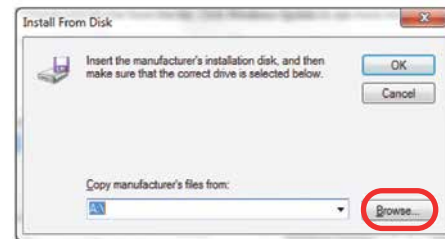

11. Click **EpilogWinALL** file and click **Open**.

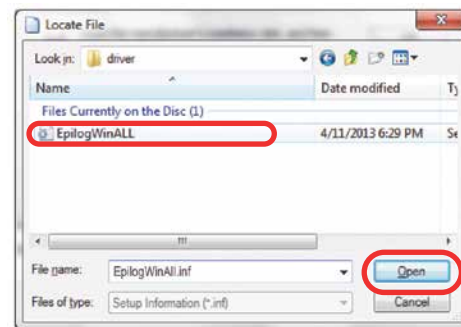

12. Click **OK**.



SECTION 3: DRIVER INSTALLATION

13. Click **Next**.

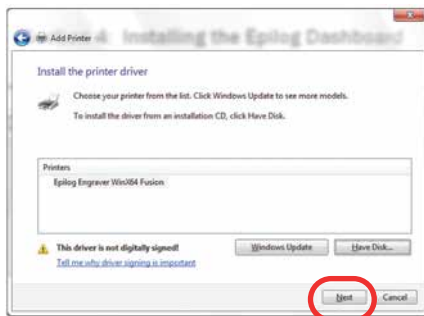

14. Click **Replace the current driver** if requested, then click **Next**.

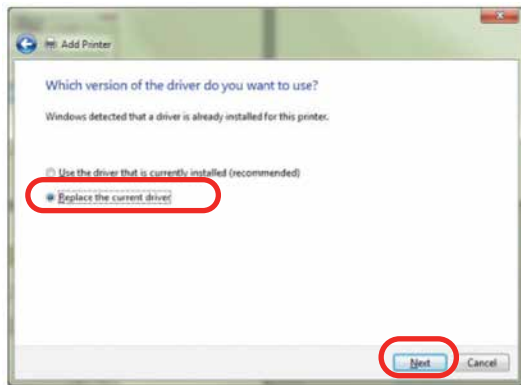

15. You can rename your printer here. We have not changed it for this document, but many users like to associate the driver name with the IP Address they are using, for example Epilog Helix 192.168.3.4. This is especially helpful if there is more than one laser connected to a single computer. Click **Next**.

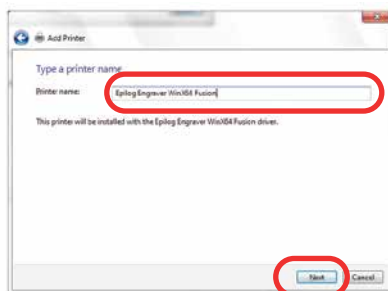

16. If you see this screen, click **Install**.

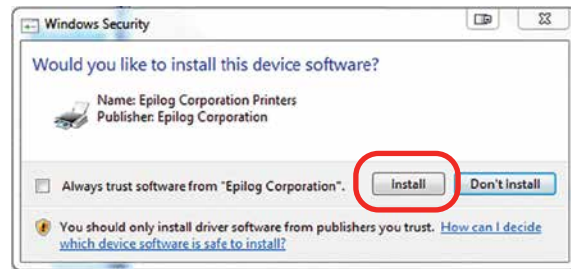

17. Click **Next**.

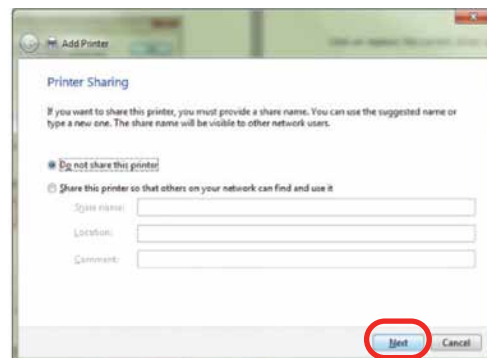

18. Click **Finish** and your driver is installed.

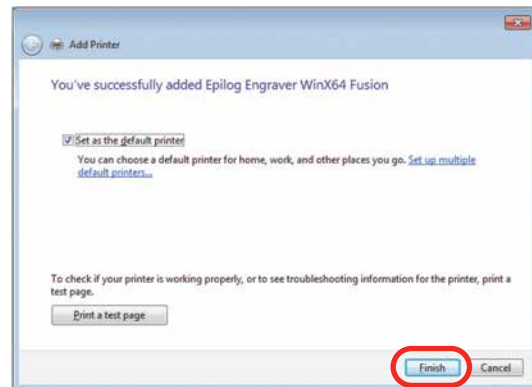

19. **You must now restart your computer** before you continue.

SECTION 3: DRIVER INSTALLATION

Windows 7: USB Installation

Windows 7: USB Installation

Please follow these instructions closely! Using a different process to install the Dashboard driver is likely to fail if you are using Windows 7.

1. Insert the Epilog driver install disc into your computer (or download the files from the website). One of the following screens will appear. For the USB installation, you will want to close them. We do not want the computer to automatically try to install the driver.

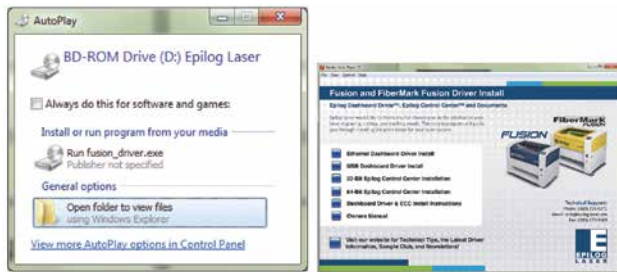

2. With the power of your laser turned off, **connect the USB cable** to your computer and your laser.
3. **Power on your laser system.** It will take about a minute for the laser to initialize. After it initializes it will start the process of installing the driver. You will see activity on the USB icon in your system tray (lower right corner of your computer screen).



4. A small window will appear in the lower right corner of your computer screen that indicates installation was successful. This is only partially true.
5. After a short wait you will see another small window

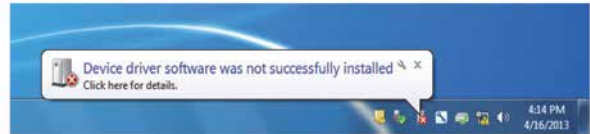

that indicates the installation was not successful. This is what we hope to see and will lead us to the next step in the process. If your computer is connected to the Internet, it will take a few minutes for your computer to display these windows. Please be patient during this process and let the computer finish trying to install the drivers. Interrupting the computer at this point will require you to restart the process.

6. After the failure notification, go to the Windows start key (lower left corner of your computer screen). Click **Devices and Printers**.

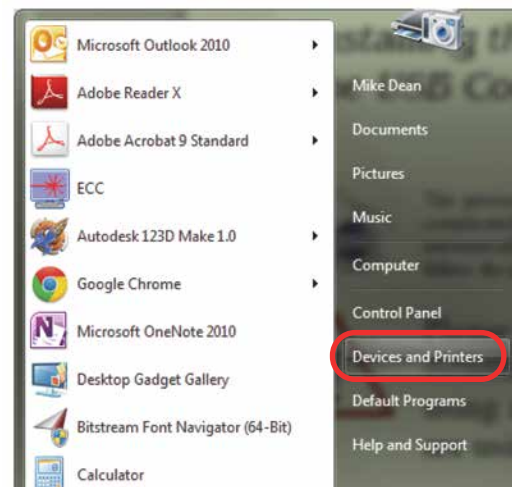

SECTION 3: DRIVER INSTALLATION

7. Right click on the **Mini or Helix icon**. Then click **Properties**.

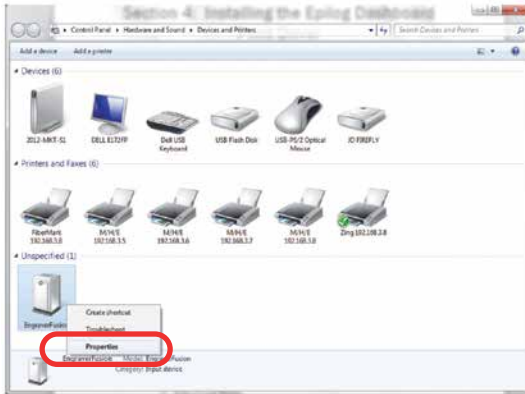

8. Select the **Hardware** tab.

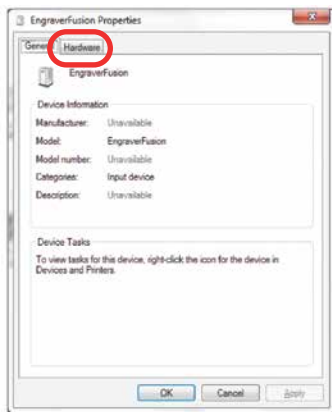

9. Select the device **EpilogEngraver** then click **Properties**.

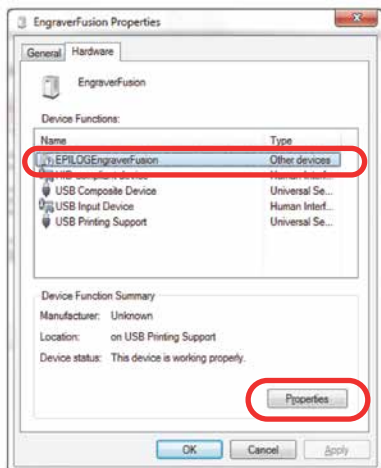

10. Click **Change Settings**.

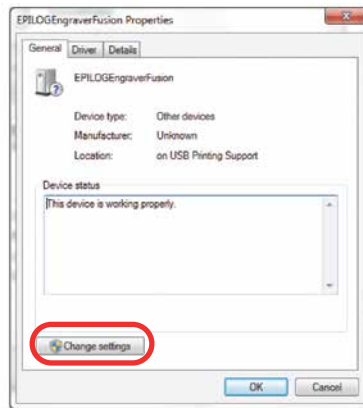

11. Click the **Driver** tab.

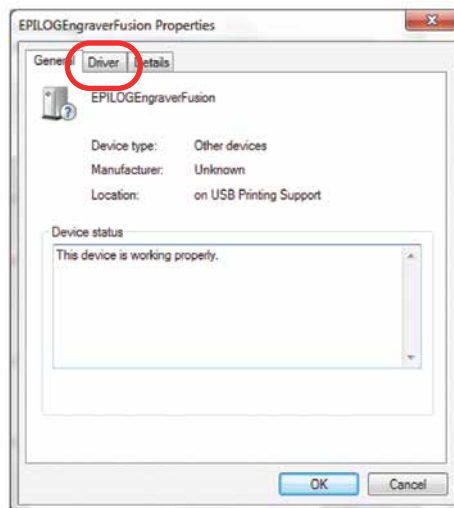

12. Click Update Driver.

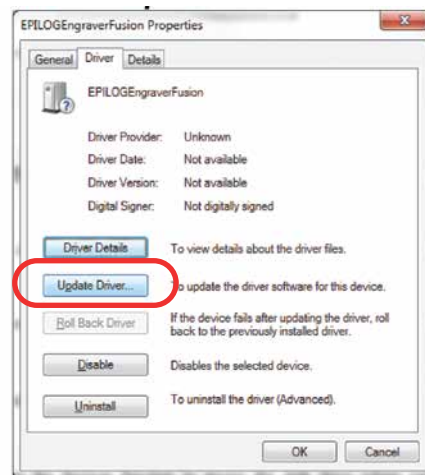

SECTION 3: DRIVER INSTALLATION

13. Click **Browse my Computer for driver software.**

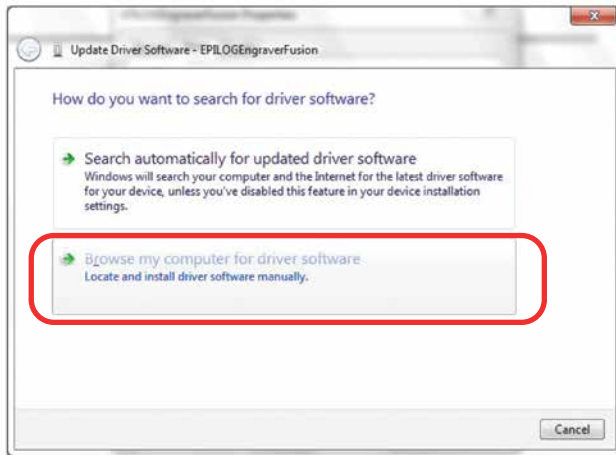

14. Use the **Browse** key to direct your computer to your disc drive that contains the Epilog driver disc that you inserted earlier in this process. (You can also download the latest driver from epiloglaser.com/tech-support/epilog-drivers.htm.)

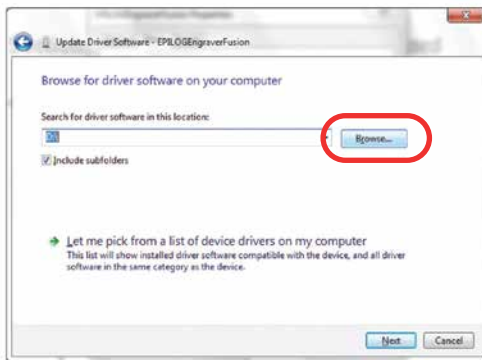

15. For this document we show the DVD RW drive as the drive where the disc is located.

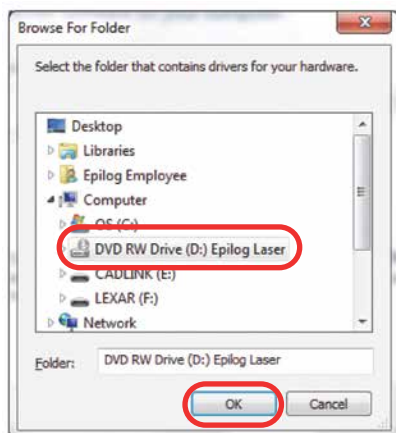

16. Once you have the proper disc drive showing click on the **Next** key.

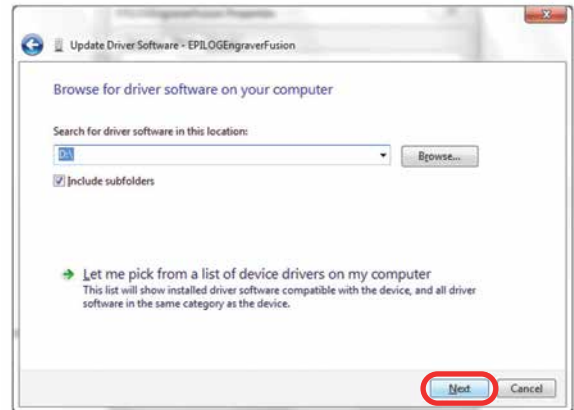

17. The progress window will appear.

18. If you see this screen, click **Install**.

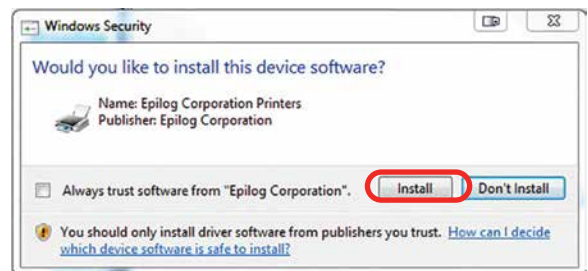

19. Your Epilog Laser Dashboard print driver has been successfully installed on the USB port. Click **Close**.

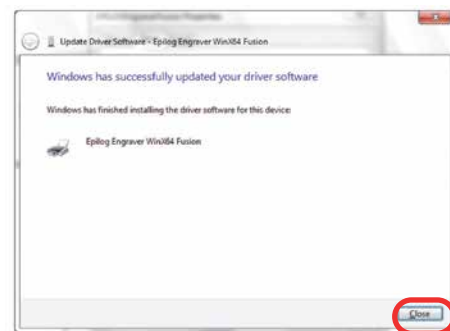

20. Click **Close** in the next window and then **Close** again. You will then see your laser driver in the Devices and Printers page. Click on the red X in the upper right corner of this page. That's it! You are ready to print to your laser.

SECTION 3: DRIVER INSTALLATION

Windows 8 and 10: Ethernet Installation

Windows 8 and 10: Ethernet Installation

Set Up TCP/IP Address in the Computer

1. Go to your **Network and Sharing Center** in your computer's **Control Panel**.

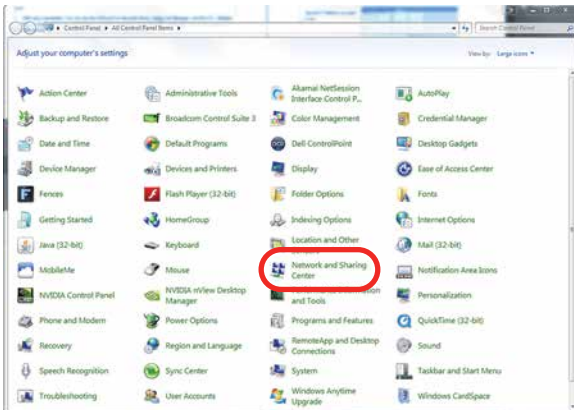

2. Click **Change Adapter Settings**.

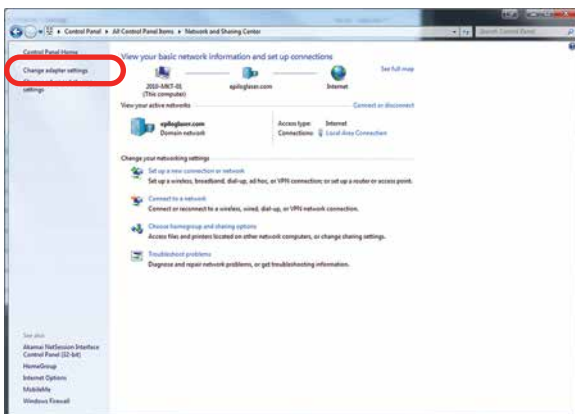

3. Right click **Local Area Connection**, then click **Properties**.

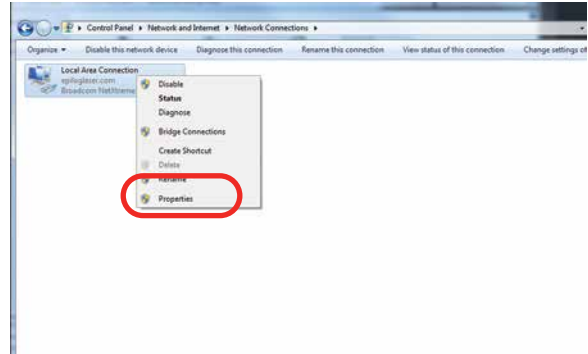

4. Select **Internet Protocol Version 4 (TCP/IP)**. Make sure you do not select Version 6.

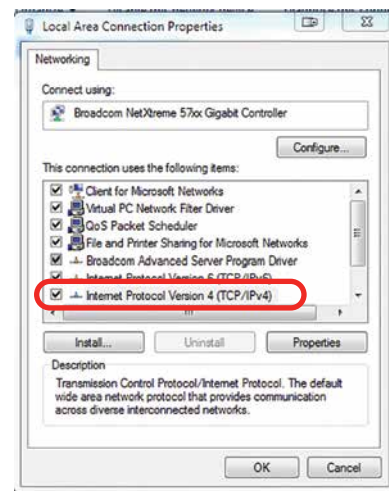

5. Select **Use the following IP Address**. Type in the following IP Address: **192.168.3.3**.



This number is not an error; the last digit of the IP address in **this window must be different than the IP address you set in the laser.**

SECTION 3: DRIVER INSTALLATION

Windows 8 and 10: Ethernet Installation

6. Type in a Subnet Mask of **255.255.255.0**, then click **OK**.

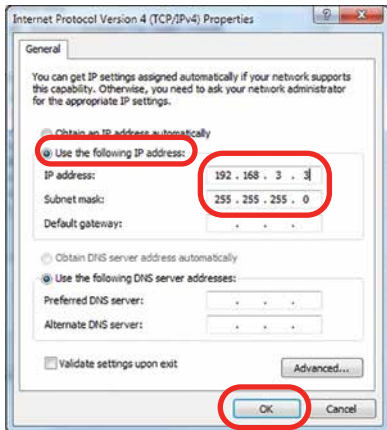

Installing the Driver

1. Insert the Driver CD in the computer and select your laser system.



2. Select the Dashboard Driver.



You can also download the latest driver from epiloglaser.com/tech-support/epilog-drivers.htm. Go to **Devices and Printers** on your computer and click **Add a Printer** to start the process.

3. **Windows 8 and 8.1/10 have different paths.** Choose your operating system:

In Windows 8:

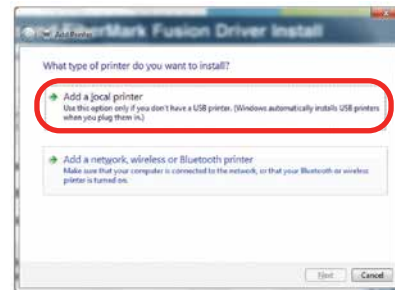

In Windows 8.1/10:

Select **The printer that I want isn't listed**.

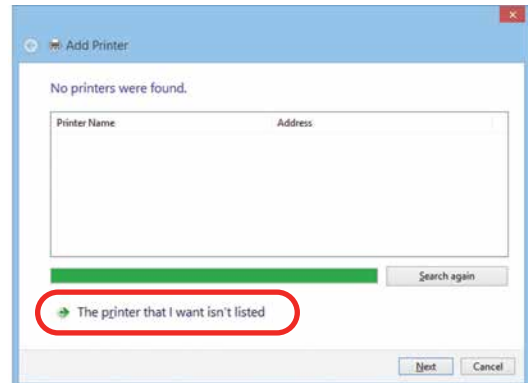

Click **Add a local printer or network printer with manual settings**. Click **Next**.

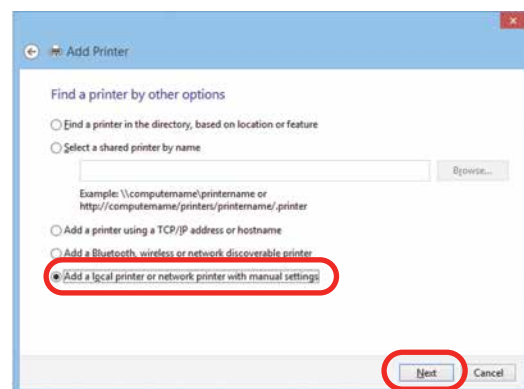

SECTION 3: DRIVER INSTALLATION

Windows 8 and 10: Ethernet Installation

4. Select **Create a new port**, then **Standard TCP/IP Port**. Click **Next**.

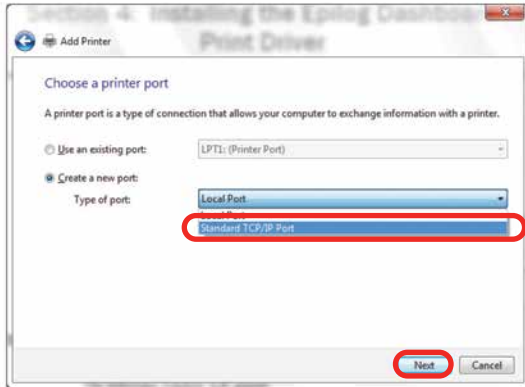

5. Enter the IP Address to match the IP Address you set at the laser in **“Setting the IP Address”** on page 15. Most Epilog users will use the IP Address of 192.168.3.4, which is what we use in this document. After typing in the IP Address, click **Next**. Wait while the computer identifies the port.

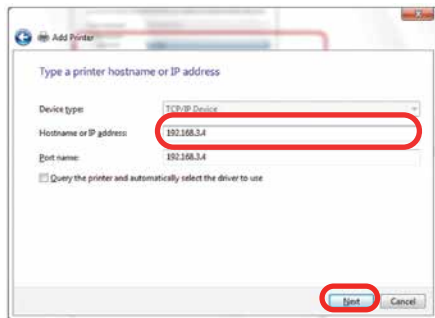

6. Select **Custom**, then **Settings**.

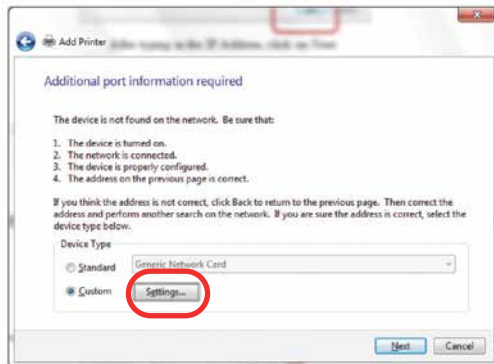

7. **Set Protocol to LPR**. This is a very important step. Your download time will be greatly increased if LPR is not selected. Type **Legend** into the Queue Name and click **OK**.

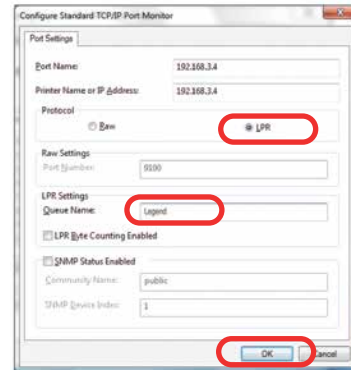

8. Click **Next**.

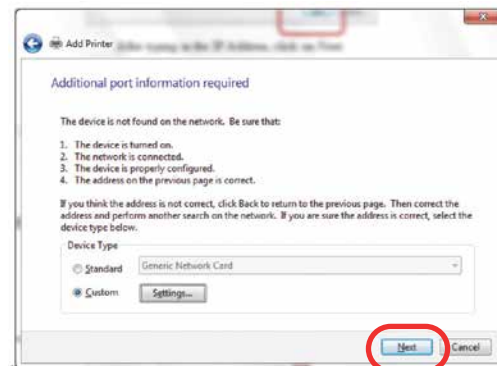

9. Click **Have Disk**.

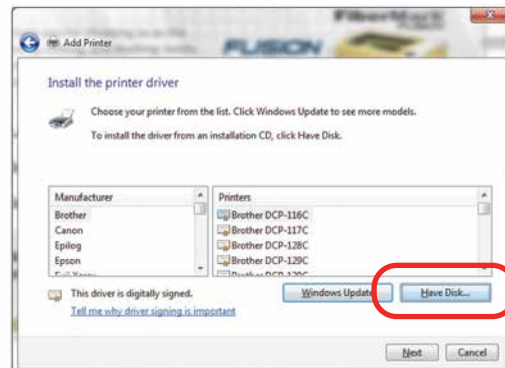

SECTION 3: DRIVER INSTALLATION

Windows 8 and 10: Ethernet Installation

10. Click **Browse**, browse to the folder where you saved the download. The default location is c:/minihelix_ driver.

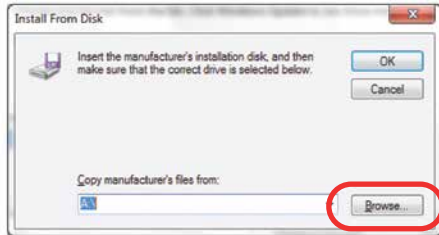

11. Click **EpilogWinALL** file and click **Open**.

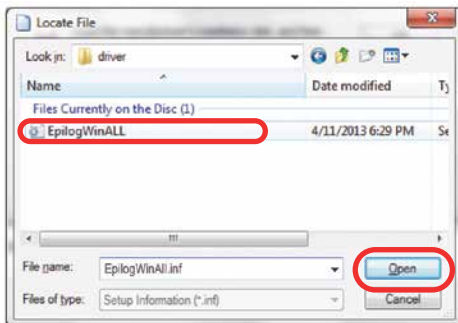

12. Click **OK**.



13. Click **Next**.

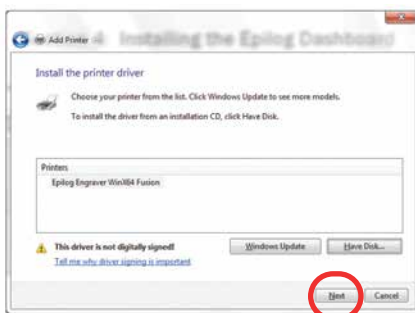

14. Click **Replace the current driver** if requested and click **Next**.

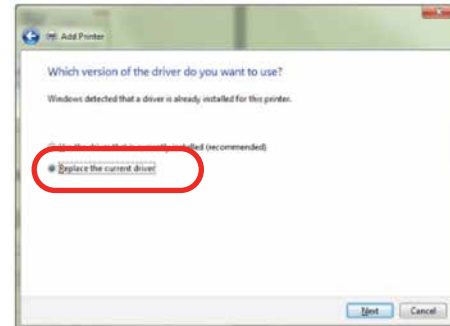

15. You can rename your printer here. We have not changed it for this document, but many users like to associate the driver name with the IP Address they are using, especially if there is more than one laser connected to a single computer. For example, we might rename the driver **Helix 192.168.3.4**. Click **Next**.

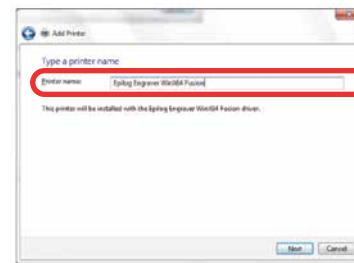

16. If you see this page, click **Always trust software from "Epilog Corporation"** then **Install**.

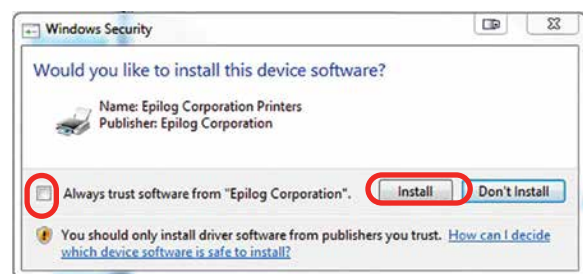

SECTION 3: DRIVER INSTALLATION

Windows 8 and 10: USB Installation

17. Click **Next**.

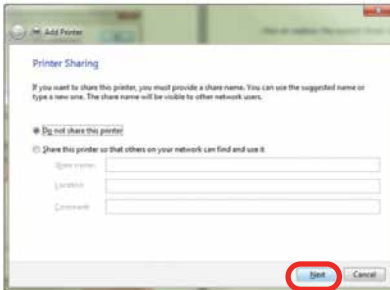

18. Click **Finish** and your driver is installed.

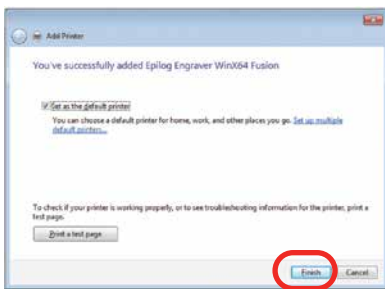

19.  **You must now restart your computer** before you print to the laser.

Windows 8 and 10: USB Installation

Windows 8 will not automatically walk you through the installation process so it is important to follow the instructions below.

1. Insert the Epilog driver install disc into your computer (or download the files from the website). One of the following screens will appear. For the USB installation, you will want to close them. We do not want the computer to automatically try to install the driver.

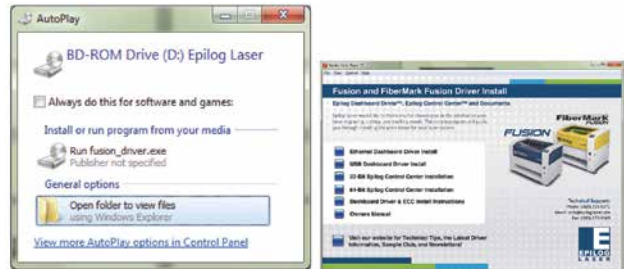

2. With the power of your laser turned off, **connect the USB cable** to your computer and your laser.
3. Power on your computer, **then** connect the USB cable to your computer and your laser.
4. Power on your laser system. It will take about a minute for the laser to initialize.
5. Once your laser has initialized, there will not be any real indication on your Windows 8 computer that it is ready to install the Epilog driver, but it is ready.

SECTION 3: DRIVER INSTALLATION

Windows 8 and 10: USB Installation

6. In **Windows 8**, open the Charms Bar and click on the **Search** charm. To access the Charms Bar move your mouse into the lower right corner of your display.



7. Type the word **Control** into the search bar. Click on the Control Panel box under Apps in the upper left of this window. In **Windows 10**, you can search for this from the desktop.

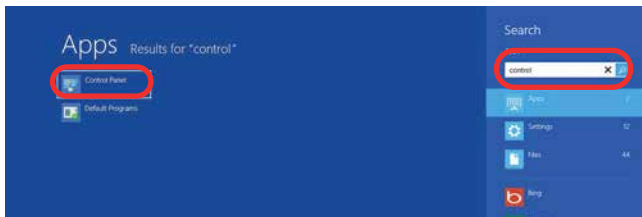

8. Click **Devices and Printers**.

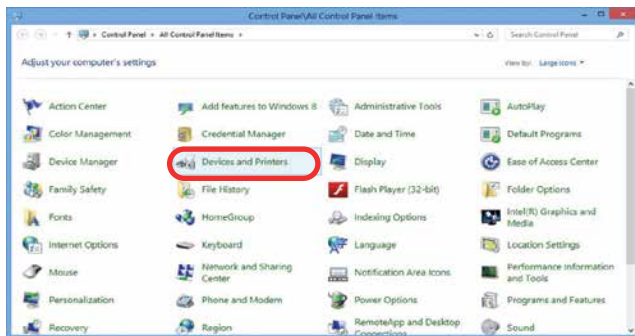

9. In the Unspecified section of Devices and Printers, **right click on the laser's icon**, then click **Properties**.

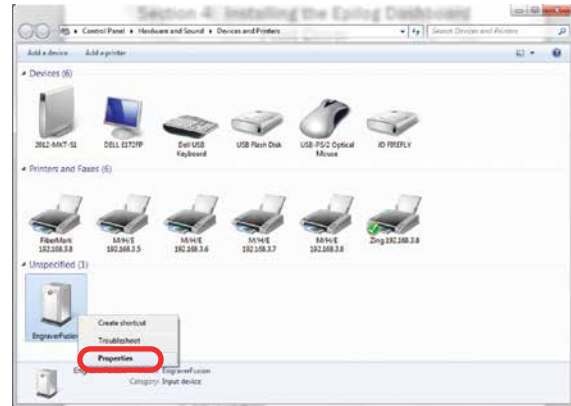

10. Select the **Hardware** tab.



11. Select the device **EpiLogEngraver**. Then click **Properties**.

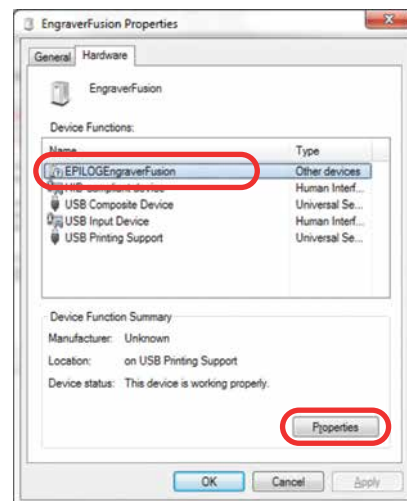

SECTION 3: DRIVER INSTALLATION

Windows 8 and 10: USB Installation

12. Click **Change Settings**.

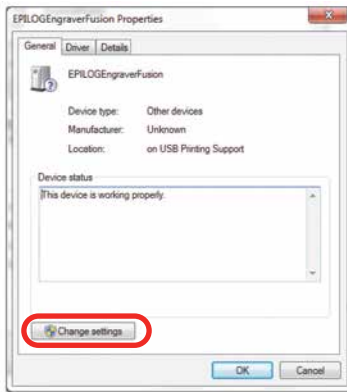

15. Click **Browse my Computer for driver software**.

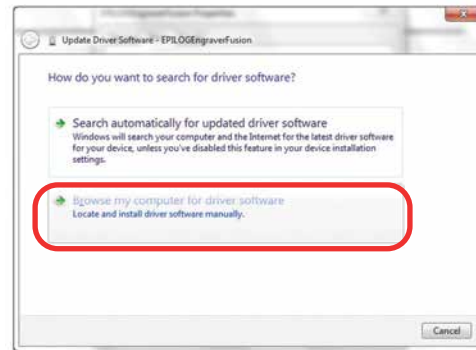

13. Click the **Driver** tab.

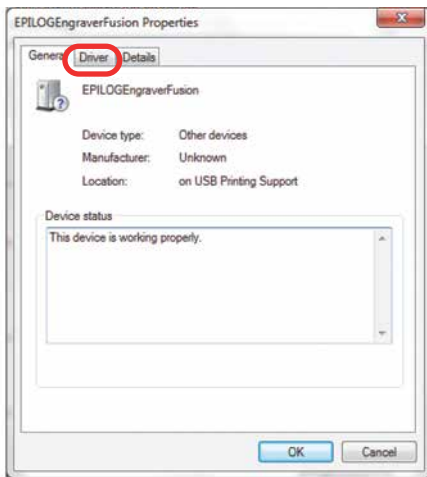

16. Use the **Browse** key to direct your computer to your disc drive that contains the Epilog driver disc that you inserted earlier in this process.

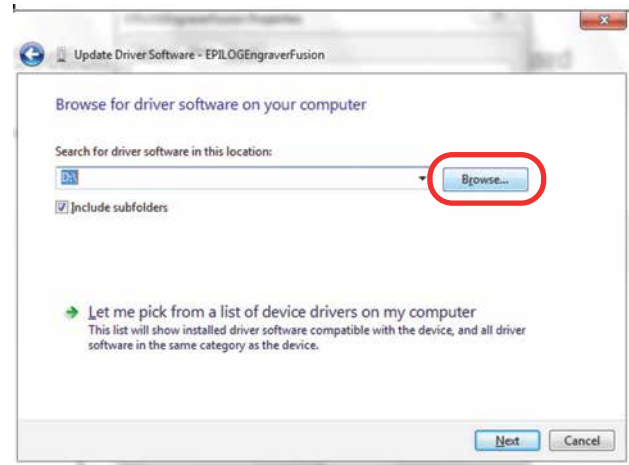

14. Click **Update Driver**.

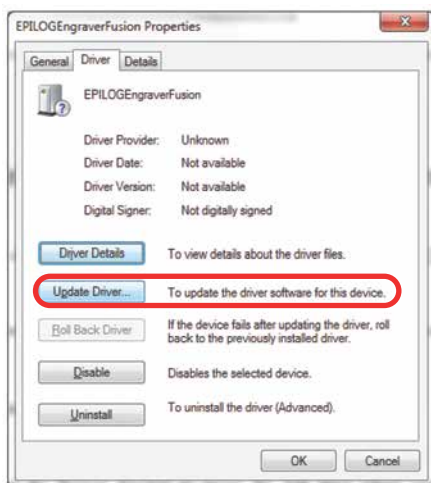

17. Find the disc drive with the Epilog install disc and click **OK**.



SECTION 3: DRIVER INSTALLATION

Windows 8 and 10: USB Installation

18. Once you have the proper disc drive showing click the **Next** key.

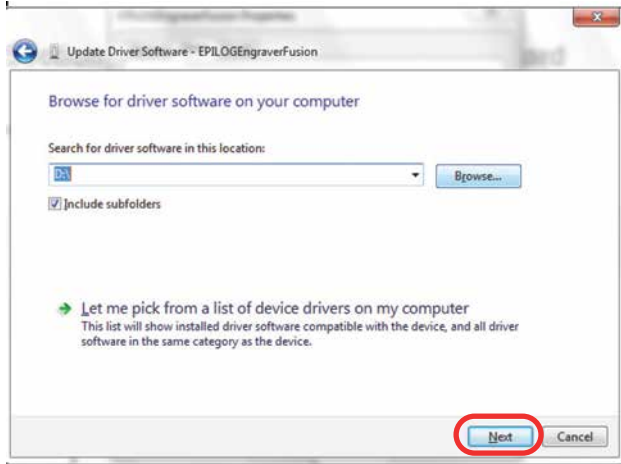

19. Wait while until the progress window disappears, then you may be asked if you want to install this driver. Click **Always trust software from "Epilog Corporation"** then **Install**.

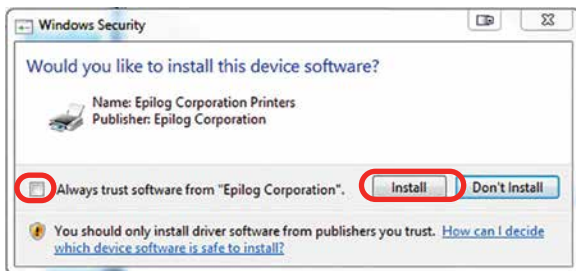

20. Your Epilog Laser Print Dashboard has been successfully installed on the USB port. Click **Close**.

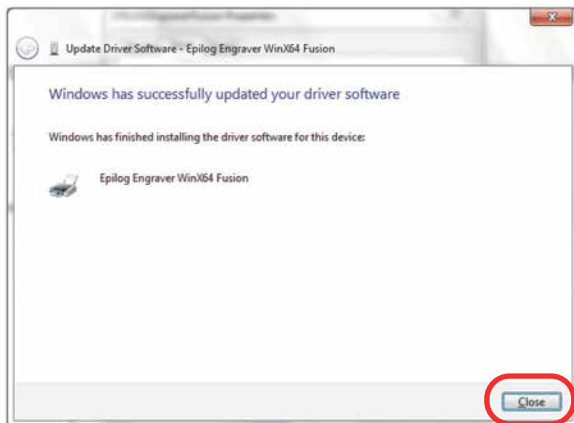

21. In the next window, click **Cancel**.

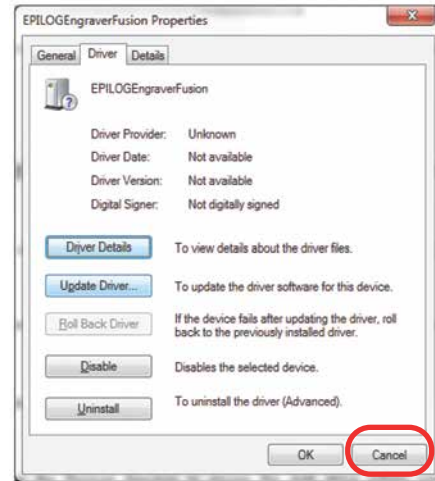

22. You will see your driver in the Devices and Printers page. Click on the **red X** in the upper right corner of this window and you are ready to print!

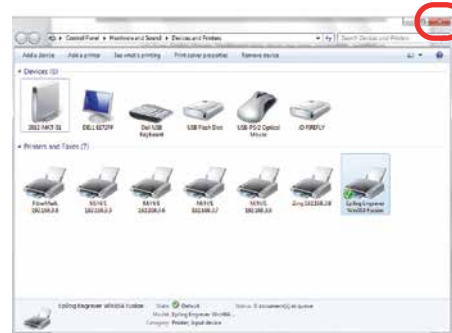

SECTION 4: THE EPILOG JOB MANAGER

Epilog Job Manager Instructions

The Epilog Job Manager is a powerful new tool that will quickly become one of your favorite features on your laser system. From one piece of software, you can access any job you have sent to the laser, view the settings you used on any past job, re-run projects, access your material database, and much more. It's a great addition to the Epilog Laser product features, and we look forward to seeing how our customers use this software!

- **Windows 7/8/10 is required** to use the Epilog Job Manager.

How to Install the Epilog Job Manager

1. If you have a previous version of the Epilog Job Manager installed, **you must uninstall it** before you continue.
2. On your driver CD, select the Job Manager.



You can also download the Job Manager from epiloglaser.com/tech-support/drivers.htm.

3. In Windows 8 or 8.1 you **may** see this message. Click **More Info**.

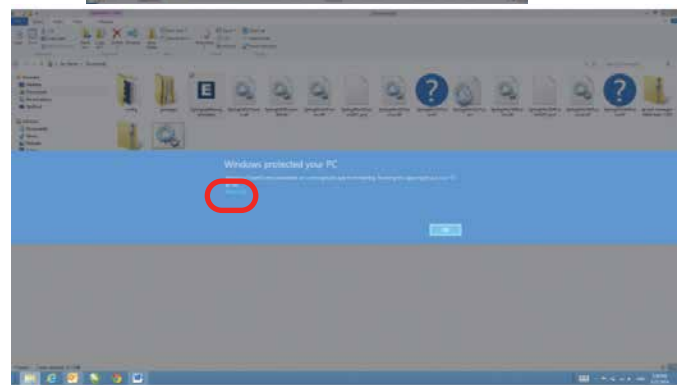

4. Click **Run Anyway**.

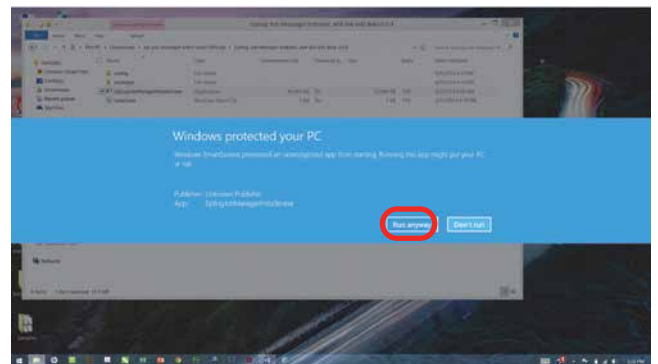

5. Click **Next**.

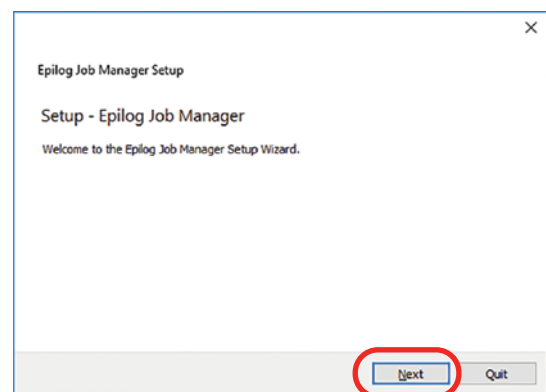

SECTION 4: THE EPILOG JOB MANAGER

How to Install the Epilog Job Manager

6. Click **Next**.

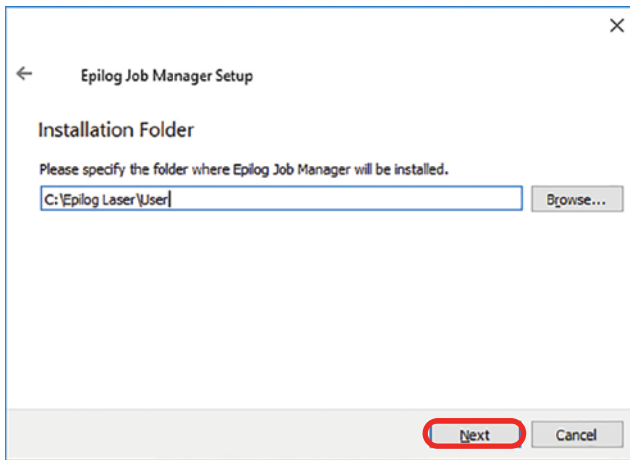

9. Click **Next**.

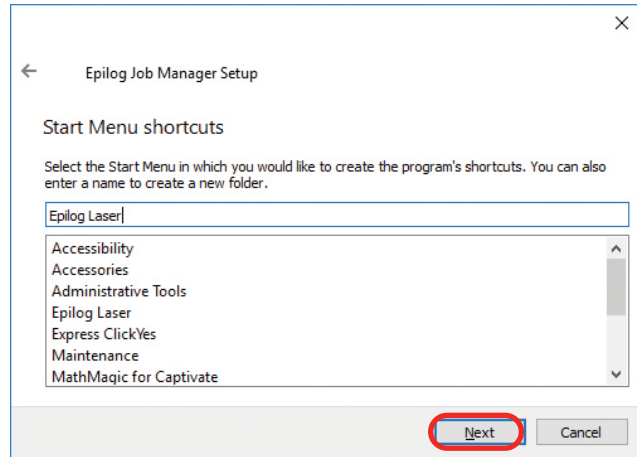

7. Click **Next**.

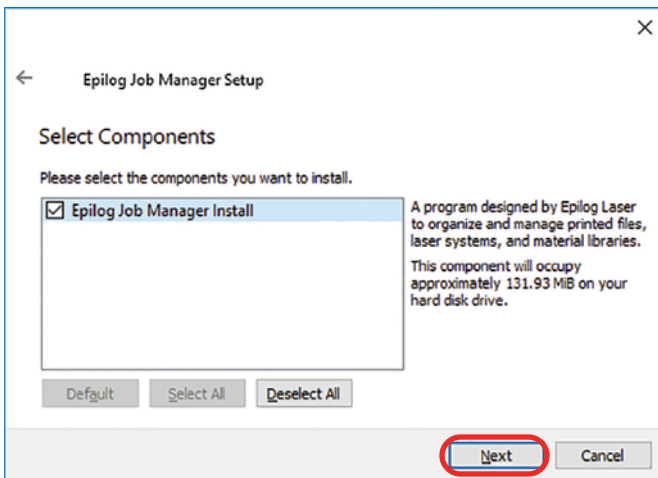

10. Click **Install**.

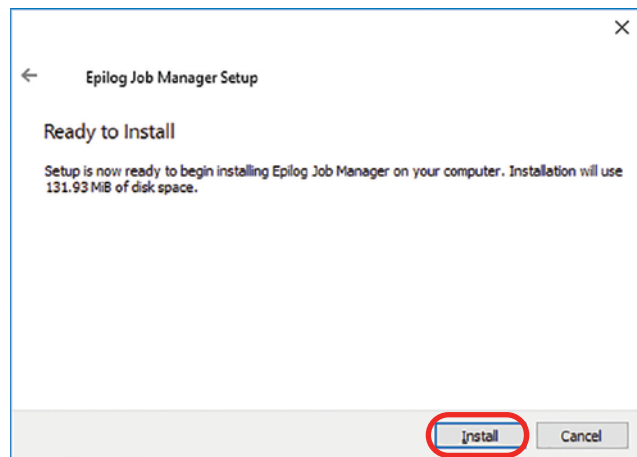

8. **Accept the license**, then click **Next**.

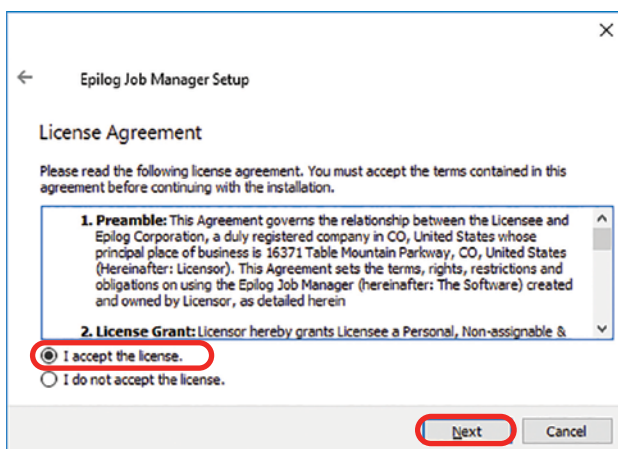

11. The installation will take a few moments.

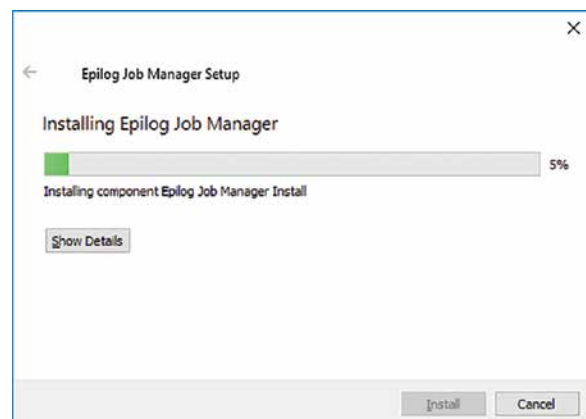

SECTION 4: THE EPILOG JOB MANAGER

Trouble Shooting Job Manager Installation

12. Click **Finish** and the Job Manager is installed.

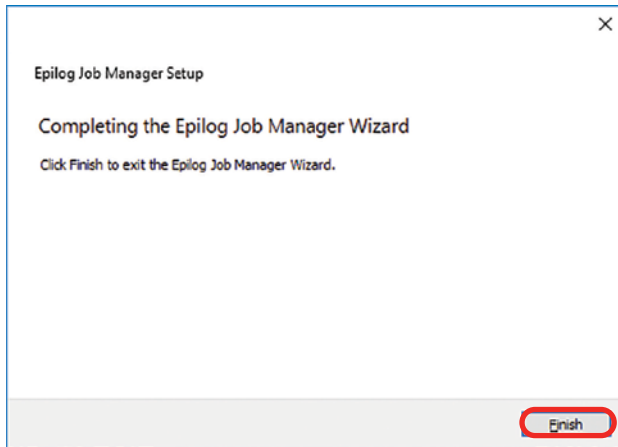

13. A Job Manager icon will be automatically added to your Desktop. You are now ready to use the Job Manager.



Trouble Shooting Job Manager Installation

If you were unable to install the Job Manager it's possible that your Anti-Virus software is blocking installation.

To disable Symantec Anti-Virus software, choose **Options**. Other anti-virus packages should have something similar to Symantec.



Disable all Virus and Spyware Protection Features. After the Job Manager has been installed go back into your Anti-Virus software and re-enable the setting that was disabled.

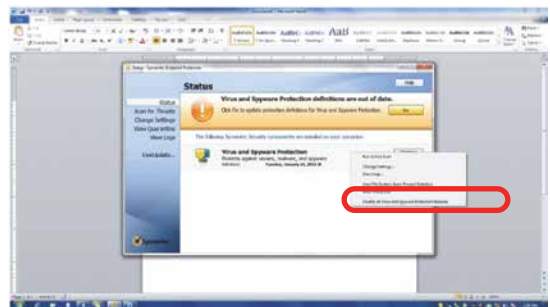

SECTION 4: THE EPILOG JOB MANAGER

Important Epilog Job Manager Notes

Important Epilog Job Manager Notes

-  **Warning:** Before activating your laser, install the newest version of the driver to properly associate the correct machine with the Job Manager.
- We suggest a **minimum of 1 GB of free RAM** space when managing very large raster and vector jobs.

Using the Epilog Job Manager

Activate a Laser

1. The first time you open the Job Manager you'll see a tab for each of the models. You will need to activate your laser system to get started. **Click the correct tab, then your system.** You can activate multiple machines if you have more than one laser.



2. To activate your machine:

- **Machine Name:** Give your machine a name (Epilog Helix).
- **Printer Name:** Select your installed laser from the drop-down list. Important - if you do not choose the correct printer you will not be able to print from the Epilog Job Manager!
- Select the correct machine series, wattage, etc. The Laser Power is very important because it will automatically load the proper material setting files for your specific wattage of laser.
- Click Save.

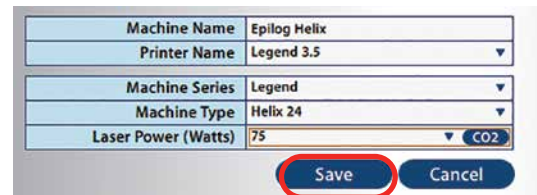

SECTION 4: THE EPILOG JOB MANAGER

Using the Epilog Job Manager

3. Your new laser has been activated in the Job Manager and appears in the left panel. Use the **Add or Delete** keys to add additional machines or to remove a laser. The Job Manager is now ready to accept jobs from the print driver.



Printing to the Epilog Job Manager

Create a file in your graphic software and set your laser parameters in the print driver.

In the driver you'll see a selection available under the Center-Engraving area. You can choose to print to either the printer (your laser system), the Job Manager, or both. This allows you to send your job to the Job Manager without sending it to the laser so you can then print that job directly from the Job Manager at a later time without accessing your graphic software. This is an easy way to set up an entire day's jobs all in one place.

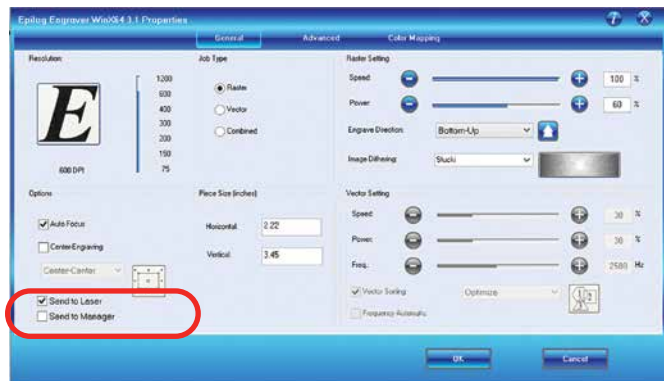

Organizing Your Print Jobs

Click the **Jobs** tab. All print jobs will be displayed in the Uncategorized folder. Click on your job to highlight it. You can now Print, Edit, Preview or Delete this job using the available icons.

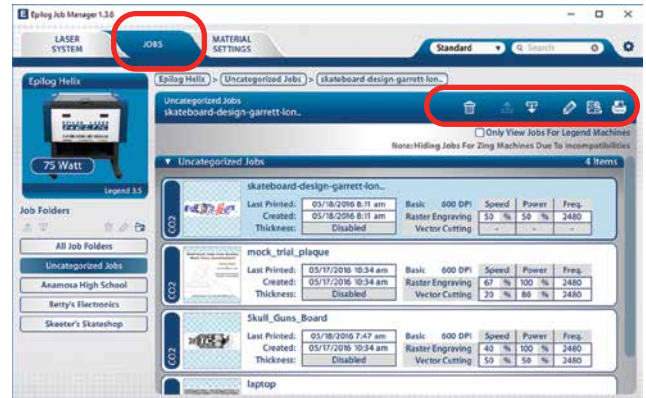

Create and Delete Job Folders

Click the **Add Job Folders** icon to add folders. We added folders for this customer's three largest customers. You can add as many folders as you'd like.

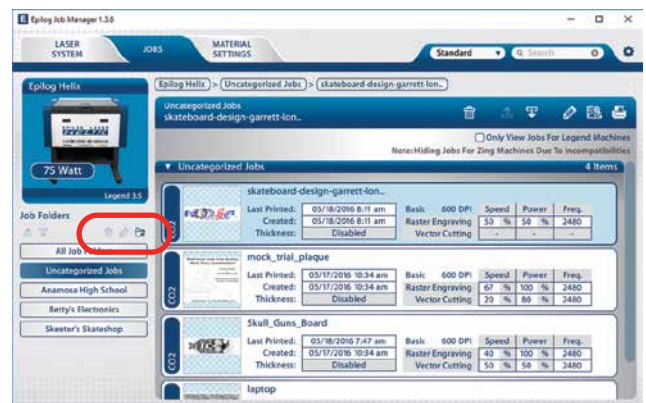

SECTION 4: THE EPILOG JOB MANAGER

Using the Epilog Job Manager

Move an Uncategorized File to a Folder

When you highlight a folder you will see **From Uncategorized** on the right side of the folder. Click **From Uncategorized** to move a job from the Uncategorized folder to this subfolder. **Select the job** you want to move and click **OK**.

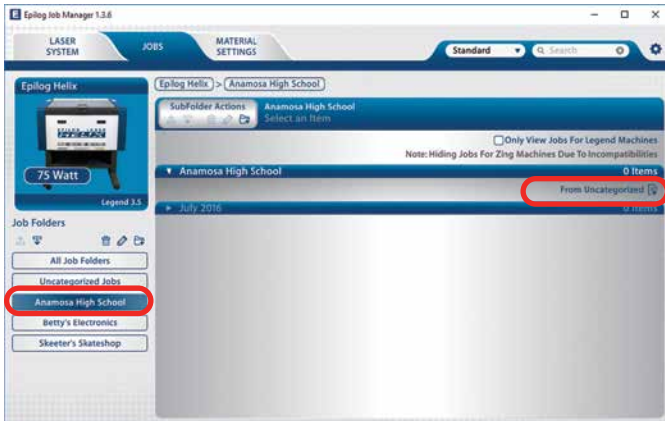

Select the job you want to move and click **OK**.

Create Subfolders

First highlight the folder in the left panel where you want to add a subfolder. Below we have highlighted the Anamosa High School folder. Click the **Add Subfolder icon**. Type the subfolder name in the **Add SubFolder** field, then click the **check mark** to create the subfolder.



Move a Job Between Folders

You can also move any job to another folder or subfolder by **double-clicking on the job**. Select the Folder and Subfolder from the drop-down menus where you want to save the job. You can save the job with the same name or you can save as a new job. You can also modify your laser settings and save them with the job. Click **Save** to continue.

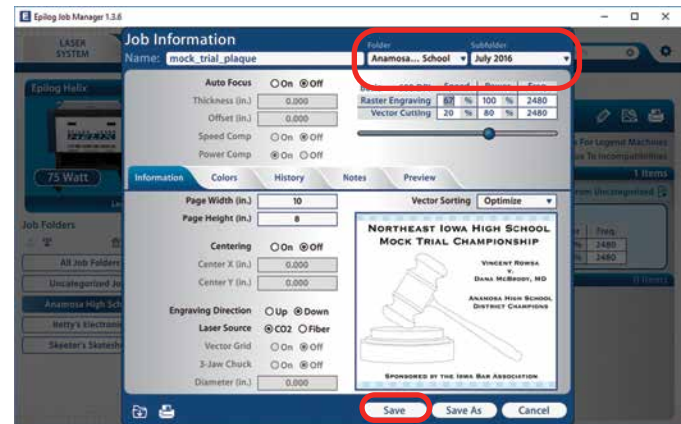

Using the Material Setting Configurations

The Material Settings tab stores all of the suggested laser parameters like speed, power, etc. These settings were loaded based on the wattage you specified in the Laser System tab (adding your laser was the very first thing you did to start using the Job Manager).

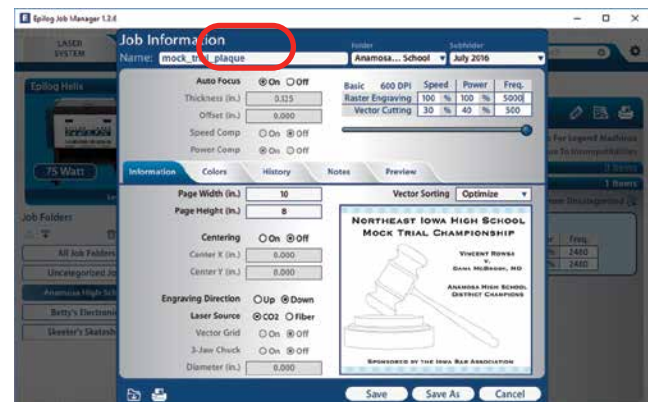

SECTION 4: THE EPILOG JOB MANAGER

Using the Epilog Job Manager

To use the material settings that are automatically loaded in your Job Manager, go to the **Jobs** tab and **double-click on the job** you want to process.

Click the **Import** icon.



Navigate to the material setting you need. We have highlighted **1/8" Cherry/Alder/Walnut 600 DPI**. Click **Save**. Your new settings will be automatically applied to your job file.

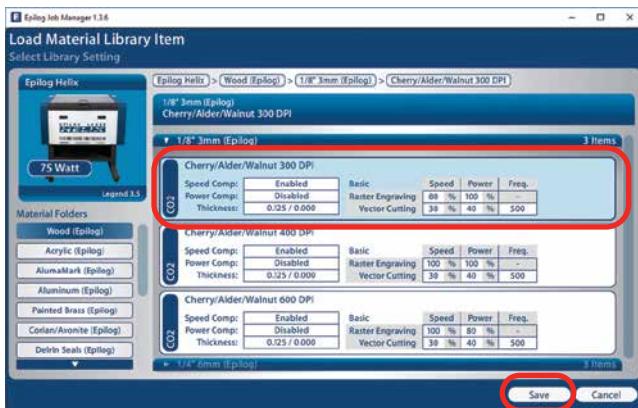

You can now save this file, save the file as a different name or print from this window.

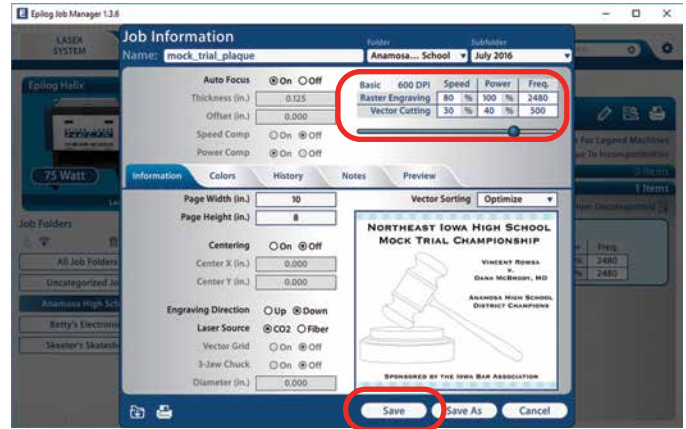

Previewing Your Job

To view a preview of the job, click the **Preview** tab.

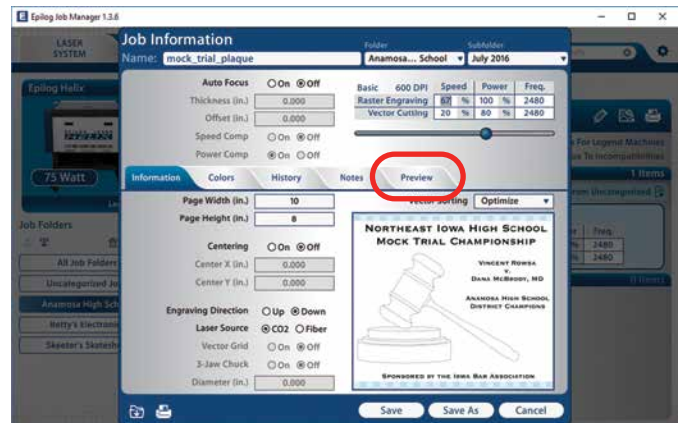

SECTION 4: THE EPILOG JOB MANAGER

Using the Epilog Job Manager

In the Preview mode you can preview just the raster components of your job, or just the vector components. We have selected vector to show only the vector components of this job. The preview mode is very useful in identifying unwanted vector components in a job.

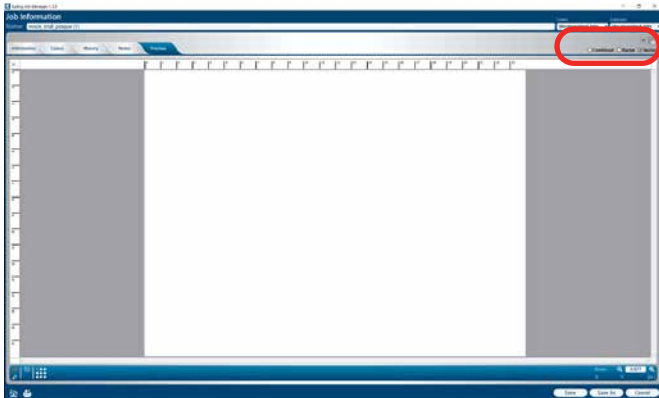

Notice that the jobs are displayed differently if you change the search category to **Alphabetical**. Your jobs are now displayed in alphabetical order. Once the search is finished and the job is found, most users revert back to the default selection of category.

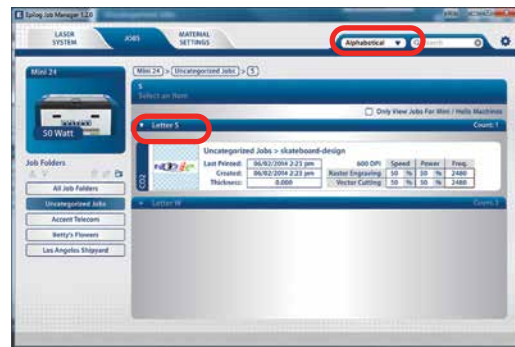

Searching For a Job

The Job Manager has a powerful search function. Type in part of a file name and press enter to find all files related to that name.

You can organize files by standard, created, last printed, or alphabetically to find a specific file.



Finding Job History

The Job Manager allows you to see a full print history of a job, including settings you used in each print. The History window shows you the history of this job, what machine it was printed to, when it was first printed (Initial Print), all subsequent prints, and all laser parameters used. To access this, double-click on the job, then select **History**.

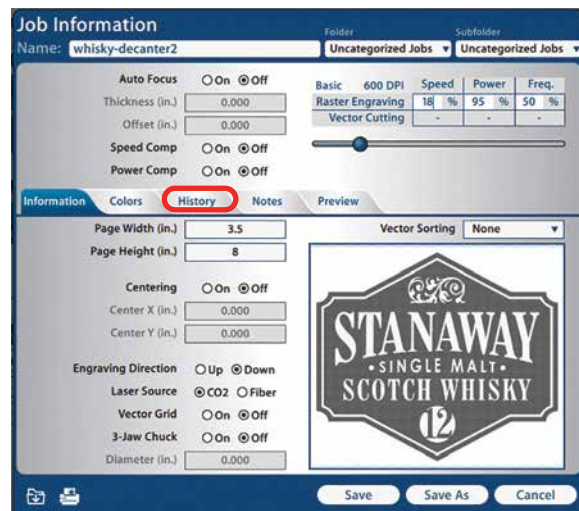

SECTION 4: THE EPILOG JOB MANAGER

Using the Epilog Job Manager

You can now modify, print or save from this window using the listed settings or with new setting. The new setting will be saved as the next print job complete with time stamp and date.

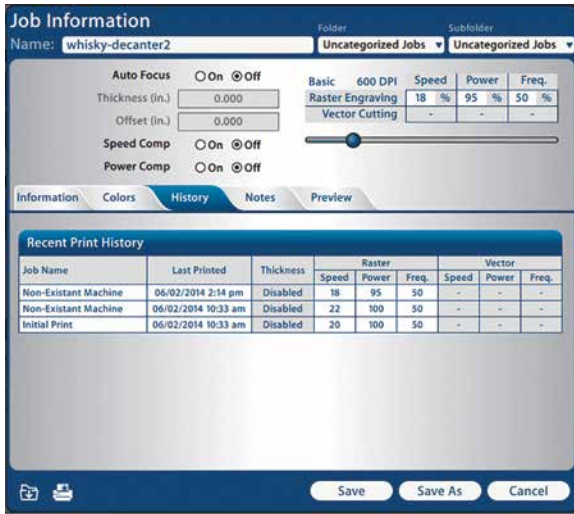

Color Mapping

To access the Color Mapping settings used in a file, double-click on the file to open the Job Information, then click the **Colors** key.

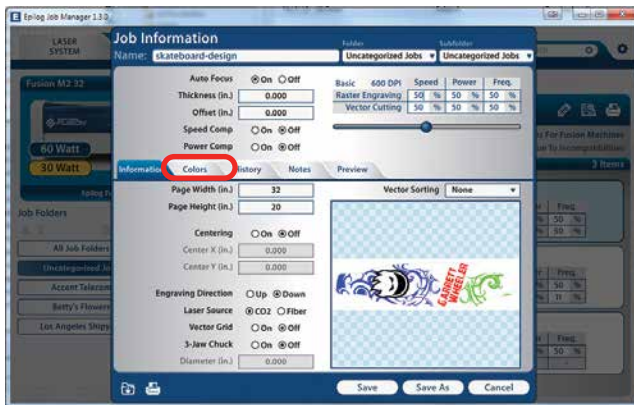

You can modify the settings, save as a new job, save as the same job, print, preview, etc from this window.

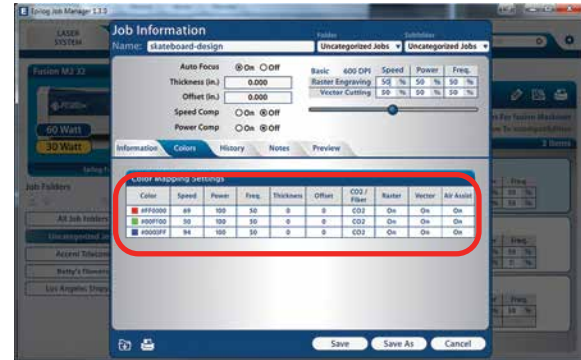

Changing Program Settings

You can access the Program Settings by clicking on the gear at the top right of the page.

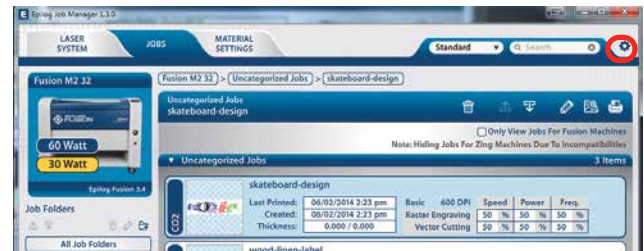

On this screen you can set several different system settings, including:

- **Language:** Choose from several languages.
- **Default Length Units:** Choose from inches, millimeters, or centimeters.
- **Job/Material List Display:** To speed up job loading when you have a long job list, you may want to change to basic view for faster loading.
- **Delete Machine/Folder/Subfolder/Job/Material Confirmation:** Turn delete confirmation message on or off.
- **Backup Database:** Save a backup of all files, material settings, etc.

SECTION 4: THE EPILOG JOB MANAGER

Using the Epilog Job Manager

- **Restore Database:** Reload settings from a previous backup.
- **Clear Entire Database:** Delete all settings, machines and jobs from the database.
- **Clear All Jobs:** Delete all jobs in the database.
- **Clear Uncategorized:** Clear out all uncategorized jobs in the database.

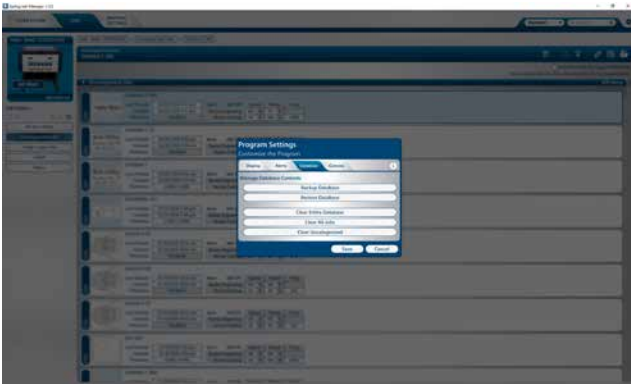

We will be adding new features to the software often, so sign up for the Driver Update Notification list at www.epiloglaser.com/register.

SECTION 5: USING THE LASER DASHBOARD™

The Epilog Dashboard is the print driver that sends your artwork and laser parameters from the computer to the laser.

The Dashboard can be installed from the driver CD that came in your accessories kit. It can also be downloaded from the Epilog website. If you are just getting started and are in a hurry to engrave a job, you can do so by setting just a couple of parameters in the Dashboard without having a detailed understanding of what different choices are available to you.



Note! When using the slider bars, there are several different ways to get the desired setting. These different methods all follow standard Windows protocol, so they will work in other Windows software applications too.

- Change the settings by clicking on the slider bar to move it, or type in exact numbers to the right of the slider.
- Holding down the Alt key while clicking close to the slider will bring up a box outlining the slider and allow you to move in increments of ten.



The following sections provide detailed explanations of the different features in the Print Driver. Most engraving and cutting jobs can be accomplished by using only the General tab of the Print Driver. Advanced features for more complex jobs can be found under the Advanced and Color Mapping tabs.

Changing Laser Dashboard Defaults

If you would like to permanently change any of the settings that we walk through on the next few pages, you can easily set a new default for each of them.

1. Go to **Control Panel | Devices and Printers**
2. Right mouse click on the Epilog Engraver.
3. Click **Properties**.
4. Click **Printing Preferences**.
5. Change any of the settings. These changes will become the default settings for each new print job.
6. Click **OK** and close out all open windows.

When would you want to do this?

Most users set their defaults to match the materials they use the most. They might set the speed default to 100% because they only engrave acrylic. They might only vector cut so they set the default Job Type to vector, or they might set the page size to match the size of the engraving table. By following these quick steps you can make sure that these are the settings you see every time you open the print driver.

General Tab

The General Tab is where you will find 90% of the features you will utilize when sending jobs to the laser. Everything from resolution to speed and power settings are all located on this one page.



1 Resolution

Set your print resolution from 75 to 1200 DPI. For the best engraving results, use a resolution equal to the resolution in the raster images within your project setup. The resolution setting in the print driver will affect the engraving time (there are twice as many engraved lines at 600 DPI as at 300 DPI) and the quality. For a detailed discussion on Resolution, visit **“Resolution” on page 63**.

2 Auto Focus

Activating the Auto Focus can be done on your computer by checking the Auto Focus box in the dashboard. If there is no check mark in this box, Auto Focus will be disabled and the table will not move up or down when the job starts. When a job is started and Auto Focus has been enabled, the table will automatically rise until the plunger comes into contact with the material at the first point of engraving. For more information on Auto Focus, see **“Auto Focus vs. Manual Focus” on page 75**.

3 Center Engraving

The Center Engraving Option allows you to define the center of your artwork as the primary reference point (Home Position) of your engraving or cutting. The Center Engraving Option has been designed to be used in conjunction with the X/Y Off feature on the Control Panel. Center engraving differs from standard printing where the upper left corner of the page and the upper left corner of the laser table define your primary reference point. For more information, visit **“Center Engraving” on page 85** in the manual.

4 Job Manager

You can choose to print to either the printer (your laser), the Job Manager, or both. This allows you to send your job to the Job Manager without sending it to the laser so you can then print the job directly from the Job Manager at a later time without accessing your graphic software. This is an easy way to set up an entire day's jobs all at one time.

5 Job Type

Choose between the three modes of operation.

- **Raster Mode:** Used for engraving or marking materials. Typical applications include engraving clipart, scanned images, photos, text and graphic images. Vector lines that you want to engrave rather than cut should be set 0.006" (0.152 mm) or greater line thickness.
- **Vector Mode:** Selected when you are running only cut lines, or for use with the Red Dot Pointer for previewing the job processing area. In vector mode, a line is recognized as a line to be cut based on the line width (or stroke). These lines can also be affected by resolution, but we'll discuss that in a later chapter. To make things easy, set any cut lines to a line width of 0.001" (.0254 mm), or hairline width in CorelDRAW.
- **Combined Mode:** Used when you engrave and cut in the same job. The laser will always engrave first, then follow with the vector cutting mode.



Note on Vectors: If you are in Vector or Combined mode, all thin lines will be vector cut! This can be disconcerting because even if the lines are not visible in your artwork they will still cut. Usually, this happens when incorporating a clipart image that has hidden lines that are not readily apparent. Please refer to "**Setting a Vector Cutting Line**" on page 63 for an illustrated explanation of how this can affect your work.

6 Piece Size

Enter the size of the page you used when creating your artwork. Some laser users prefer to design their piece with a page size matching the page they are engraving, while others prefer to design with the page size set to the full engraving table.

7 Raster Settings

Speed: Determines the travel speed of the carriage in Raster mode and is adjustable in 1% increments from 1 to 100%. The slower the speed, the deeper the engraving. Speed settings are heavily dependent on the hardness and the thickness of the material being engraved with harder materials requiring slower speeds for deeper engraving. Slower speed settings will produce greater depth of engraving. Please refer to "**Appendix B: Material Settings**" on page 143 in this manual.

Power: Determines the amount of laser energy that is delivered to the piece being cut and is adjustable in 1% increments

from 1 to 100%. The higher the power, the deeper the engraving. Please refer to “**Appendix B: Material Settings**” on page 143 in the manual.

Engrave Direction: This feature applies to raster engraving only and allows you to engrave your project either from the top-down or the bottom-up direction. In standard top-down engraving there can be a large amount of engraving debris generated, especially on materials such as plastic, wood and rubber. As the debris moves toward the exhaust plenum, some of it collects in the area that has just been engraved. Bottom-up engraving prevents the debris from collecting in the freshly engraved spaces.

Dithering: This setting defines how the dot patterns will be engraved in raster images that contain grayscale images, blends, or color. The Dashboard offers six different dithering patterns to enhance your engraving projects. The default mode is Standard. This mode can be used for all images, including photographs, but some images improve when engraved with other dithering patterns. Dithering is used only for Raster engraving and has no effect on vector cut lines. For more information, go to “**Image Dithering**” on page 77.

8

Vector Settings

Speed: Determines the travel speed of the carriage in vector cutting mode and is adjustable in 1% increments from 1 to 100%. The slower the speed, the deeper the cut. Most cutting applications require relatively slow speed settings, and the speed is heavily dependent on the hardness and the thickness of the material being cut. Slower speed settings will also produce better edge quality. High speeds are provided for draft mode only and are not intended for production applications. For more information, visit “**Appendix B: Material Settings**” on page 143.

Power: Determines the amount of laser energy that is delivered to the piece being cut and is adjustable in 1% increments from 0 to 100%. The higher the power, the deeper the cut. The amount of power necessary to cut completely through a given material is also heavily dependent on the hardness and the thickness of the material. For more information, visit “**Appendix B: Material Settings**” on page 143.

Frequency: The number of laser pulses that the laser fires per inch of travel. The frequency is set in the dashboard and can be adjusted from 1 to 5000. A lower frequency number will have the effect of less heat because fewer pulses are being used to cut the material. Lower frequency rates are helpful for products like wood, where charring is evident at higher frequencies. High frequencies are useful on materials like acrylic where a large amount of heat is desirable to melt or flame polish the edges.

Vector Sorting: A check mark in the Vector Sorting box will order the sequence of the vector cuts. You have two modes to choose from with vector sorting: Optimize or Inside-Out. In Optimize mode, vectors will be cut in the most efficient manner and will generally vector the next closed line to the one just finished. This is by far the most preferred method as it saves the most time, is the most predictable and will create a continuous line path if the line is made from disconnected line segments.

Inside-Out mode will vector from the inside object first to the outside objects last. As an example, if you have a small circle surrounded by a larger circle, the small circle will cut first.

If sorting is not checked, the vectors will cut in the order in which they are presented by the software, which most software

applications use order of creation.

Frequency Automatic: The laser frequency (pulsing) can be set to automatic. When this is enabled the laser will automatically adjust the pulsing of the laser to a value of 5000.

Advanced Tab

The advanced tab contains advanced features including 3D, stamp mode and configurations.



1 Raster Type

Basic Mode: This is the mode you will use for most engraving projects. The laser will use a uniform engraving speed and power for the graphic, providing a consistent engraving.

3D Mode: When selected, instead of looking at the dots and determining where to fire the laser based on the dot spacing, we look at the dots and determine how much laser power (wattage) to apply to each dot, allowing us to create a 3D effect when deep engraving in materials like wood. For more information go to **“3D Engraving” on page 113**.

Stamp Mode

The stamp option automatically converts your artwork into to a format that will produce a laser engraved stamp. This function automatically inverts your artwork so that the background is engraved away while your text and graphic images are left standing. It also puts a supporting shoulder around every component of the artwork.

2 Stamp Settings

The stamp option automatically converts your artwork into a format that will produce a laser engraved stamp. This function automatically inverts your artwork so that the background is engraved away while your text and graphic images are left standing. It also puts a supporting shoulder around every component of the artwork. Because of the unique nature of Stamp Mode, we have devoted a sub-section on all aspects of stamp making and printing. Please see “**Rubber Stamps**” on page 120 in this manual for detailed instructions on producing and printing

Select Stamp to enable stamp mode options.

Shoulders: Adjusts the angle of the sides of the stamp.

Widening: Adjusts the boldness of the character.

Mirror: Inverts the artwork.

Fence: Defines outer borders.

3 Update Firmware

When you are ready to update your laser’s firmware, click here and load the file. For more information, visit “**Section : Upgrading the Operational Firmware**” on page 109.

Configurations

4 The Configurations feature is a comprehensive data management tool that is used to save all of your Dashboard settings for individual jobs. Saving the Dashboard settings as a database file allows you to retrieve the job parameters at a later time. This saves you the trouble of trying to remember what speed, power and other settings you used on a job you did three months ago. All of your settings can be stored as a permanent record.

For example, in your database you can have settings for acrylic, coated steel, glass, and many more materials. After each configuration file name, you can see if the saved settings are for a Raster, Vector or Combined job, the resolution, and the piece size within that file. To use any of these settings, click the **Load** key.

If you find a setting you would like to save into a new configuration file, simply create the settings within the three Laser Dashboard tabs, then click **Save**.

The Driver Disc has a number of preset configuration files available. When you unzip your selected wattage's configuration files, they will save to c:/epilog/engraving setting. This is the default folder that the Laser Dashboard will look in to load files available for your laser. After you have found the configuration files you want to use, click on the **General tab** to see the settings that the loaded file brings up.

Color Mapping Tab

The Color Mapping feature is an advanced feature that must be checked to activate. Color Mapping is designed to be used in either Raster mode or Vector mode, but not in Combined mode. While Color Mapping is a very powerful tool, most users use it for a few main reasons:

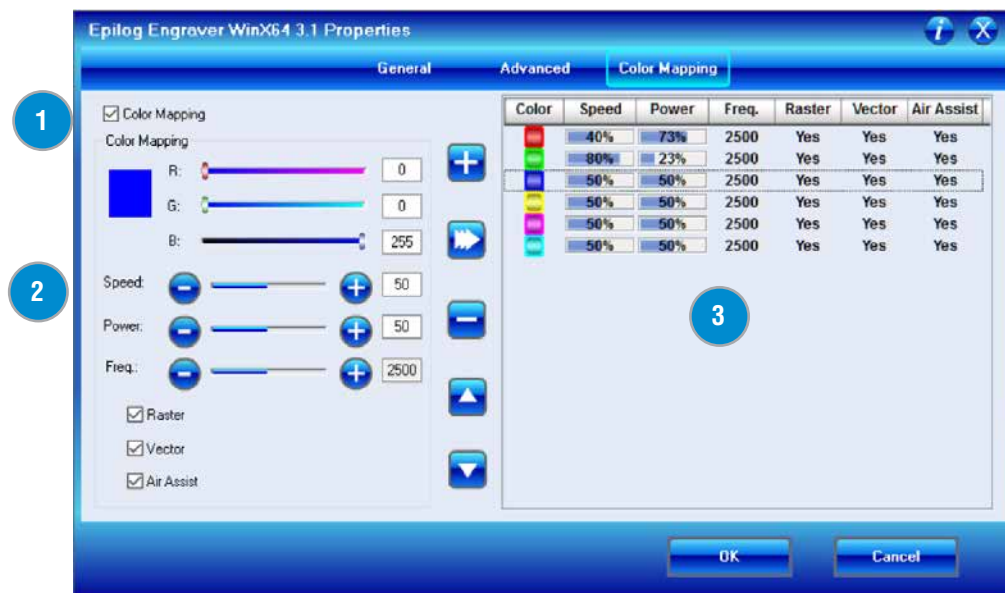

- Using color so that multiple Speed and Power setting can be used in a single print job. Multiple speed and power settings are most commonly used in Vector mode when one color is used for marking and another color is used for cutting. Using different colors allows users the ability to sequence the order that objects will be marked.
- Using different colors allows users the ability to sequence the order that objects will be cut or engraved.

Color Mapping accomplishes these tasks by assigning laser attributes to the different colors in your artwork. The functions that can be controlled by color are: Speed, Power, Frequency, Raster On/Off, Vector On/Off, Air Assist On/Off. For a detailed look at the laser's Color Mapping capabilities, visit "**Color Mapping**" on page 78.

1 Enable Color Mapping

When this check box is selected, the laser will use the settings assigned to each color. For any colors that are in your artwork, but not in the color mapping settings, the General settings will be used.

2 Adjust Settings

Use the slider bars to create any RGB color and set the laser parameters. Adjusting the settings does not actually change the values. Select the Right Arrow key to finalize the settings.

3 Color Map Summary

The Color Map Summary area is located on the right side of the window and offers a visual display of all of the color mapped settings. You can quickly see each color and the speed, power, frequency, focus, mode and Air Assist settings for each of the different colors within your file.

Additional CorelDRAW Laser Dashboard Features

Each program you use will provide different ways to manage these functions. CorelDRAW offers a very straight forward way to access each of these features.

Multiple Passes

You can automatically engrave or cut a job multiple times by setting the Number of Copies to the number of passes that you want to make. When each pass is finished the laser will automatically start another pass until all passes are complete.

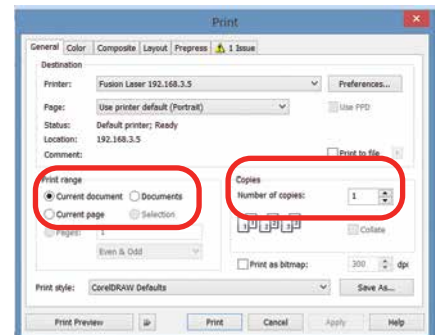

Print Range

If you only want to print one aspect of your project (for example, just the text in the document), you can select that part of the file, then click Selection and the laser will only engrave or cut that piece of your file.

Multiple Pages

When you want to engrave multiple pieces within one document, such as five different engraved glass mugs, each with a different name, you can use the Multiple Pages feature of CorelDRAW. Set up each of the mug files on a separate page in your single CorelDRAW file, then when you print to the laser you can choose either **Current document** to print all of the pages or you can specify which pages you want to print by adjusting the settings in the **Print range box**. You can view the different pages in the Print Preview screen.

When a multiple page job is printed to the laser, each of the pages will transfer to the Control Panel with the first file coming across as Job:1. File Name, then Job:2. Page 2, Job: 3.Page 3. Remember, the last page of the job will be the current file when you go to the laser's control panel, so scroll back to Job 1: File Name to run that one first.



If you start engraving the jobs and become uncertain about which pages are which, you can refer back to your print preview screen and the Page number in the laser will correspond to the page number in the print preview.

SECTION 6: MINI/HELIX CONTROL PANEL

Display

You will see one of two displays - icon only or text. The display shows valuable information associated with the highlighted Functional Menu items. We will explain the different information that will be displayed as we go through the description of each menu item.

Icon Only Display Panel:

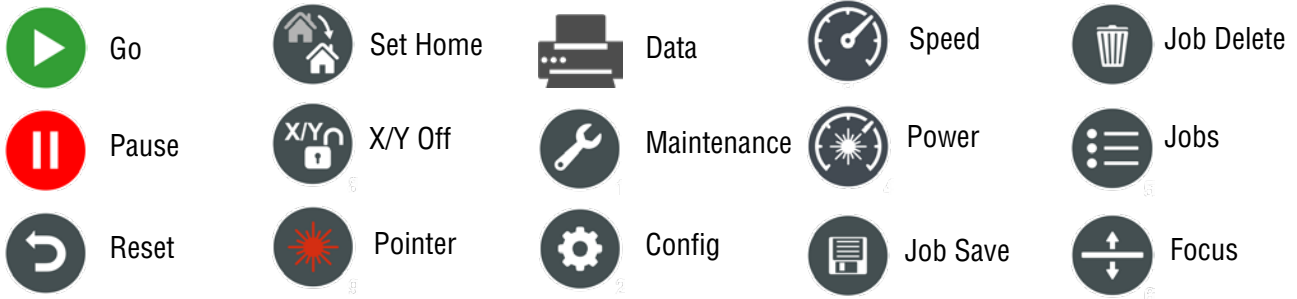

Text Display Panel:

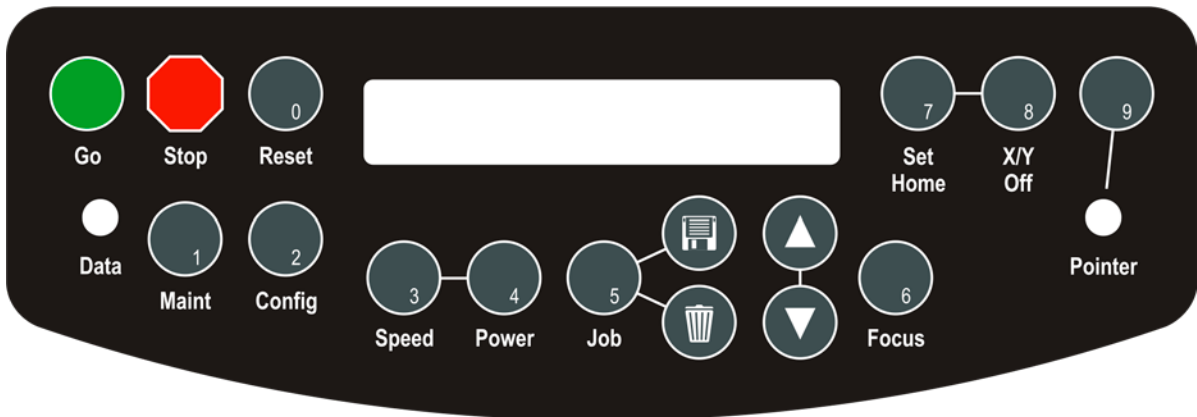

Button Functions

Go Button

- Press the Go key to start or resume a job.

Pause Button

- Pressing the Pause key will pause the lens carriage and the laser beam will be shut off. If the Pause key is pressed during raster engraving mode the lens carriage will pause on either the far left or far right of the engraving line that is in process. If the Pause key is pressed while in vector cutting mode, the lens carriage will pause at the end of a line segment or at the next line node location.
- Once the lens carriage has stopped, you can open the door to examine the engraving. By closing the door and pressing the Go key, the engraving/cutting job will commence where it left off. If the item being engraved is not moved the engraving/cutting registration will not be affected.
-  **Note:** Opening the door on the laser during engraving or cutting will stop the laser from firing; however, the lens carriage will continue to move. It is important to stop the job before you open the door to ensure the engraving/cutting is completed.
- If you press the Pause key while in vector mode it may take some time for the system to actually stop. The system needs to get to the next node in a vector before it can stop.

Reset

- Pressing the Reset key will move the carriage back to its Home Position. Press the Reset key after you have pressed the Pause key, or after you have moved the carriage when using the X/Y off function.
- Reset does not erase the job from the laser systems memory; rather it will stop the engraving job in process and send the carriage back to the Home Position.

Set Home

Once you have moved the lens assembly by hand to a temporary Home Position, pressing the Set Home key will set this new position as your new temporary Home Position. This temporary home now becomes your new upper left corner.

The process of setting a temporary Home Position involves the following steps:

1. Press **X/Y Off**.
2. Press **Go** to disable X and Y axis (press **Pause** to cancel and send the carriage back to its park position.)

SECTION 6: MINI/HELIX CONTROL PANEL

3. Move the lens assembly by hand to your desired location (remember to turn the Red Dot Pointer on as a visual locator aid).
4. Press **Set Home** to establish your new Home Position.



After you have set home, pressing the **Reset** key will move the carriage to its park position **approximately 1/2 inch (12 mm) to the front of where you set home.**

5. **Resetting Home Position:** Once you are finished with your temporary Home Position and want to restore the carriage to the upper left corner of the machine, press the **Maint** key. Press the **down arrow** to see **1. Restore Home**. Press the **Go** key and the Home Position will be restored to its normal upper left corner park position.

X/Y Off

Pressing the X/Y Off key and then pressing the Go key disables the X and Y motors and allows the operator to move the carriage by hand to any location on the table. Moving the carriage by hand allows you to perform several different functions:

1. Manually focus anywhere on the table or on the optional Rotary Attachment. To manually focus anywhere on the table, disable the axes by pressing the X/Y Off key, then the Go key. Move the carriage to the desired focus position. Place the manual focus gauge on the carriage and press the up or Down cursor keys on the keyboard to move the table up or down until the focus gauge is just touching your work. Your focus is now set to the proper focus height. After you have focused, press the Reset key to send the carriage back to its park position.
2. Accurately determine the X and Y axis location. When you disable the axes and move the carriage by hand, the X and Y axis coordinates will be displayed on the LCD panel.
3. Create a new temporary Home Position. Using the Red Dot Pointer helps to locate the precise position where you want your new Home Position to be located. Use the X/Y Off key in conjunction with the Set Home key to create a temporary Home Position.



Be careful to avoid touching the optics while moving the carriage!

Pointer



The Pointer key is a toggle switch that turns the laser system's Red Dot Pointer on and off. When the Red Dot Pointer is on, the indicator light directly to the left of the pointer key will be illuminated. For more information visit "**Red Dot Pointer**" on page 83.

Data Transfer



This light will illuminate when data is being passed to the laser. This is a handy tool when you are checking to see if your laser is connected to your computer.

Maintenance



The Maintenance key provides two menu options:

1. **Restore Home:** If you have used X/Y Off and Set Home to create a temporary Home Position, you will use this option to reset your system to the standard upper left Home Position. Press the **Maint key**, then press the **Down Arrow**. When the menu displays 1: Restore Home, press the **Go** key and the carriage will return to the upper left corner of the table.
2. **Align Laser:** This option is normally only used by the factory to align the laser beam, but it can also be used should your laser beam require alignment in the field. Please contact Epilog Technical Support at (303) 215-9171 before using this feature.

Config



There are a number of factory settings that normally only need to be set once at the factory to calibrate the system. All of the calibration settings can be accessed using the Config key. To access the configuration menu, press the Config key, then use the right arrow to scroll through the options.

1. **X Home:** Increasing this value moves X Home closer to the left ruler. Range: -600 to 0.
2. **Y Home:** Increasing this value moves the Y Home closer to the top ruler. Range: -600 to +200.
3. **X R Home:** Increasing this value moves the X Rotary Home closer to the left ruler. Range: -3000 to +600.
4. **Y R Home:** Increasing this value moves the Y Rotary Home closer to the top ruler. Range -1200 to +1200.
5. **Focus Adj:** Increasing this value will increase the gap between the focus lens and the work piece when using the Auto Focus. Range -200 to +300.
6. **Laser Match:** Establishes left to right vertical alignment of alternating raster lines. Range -20 to +20.
7. **Stamp Match:** Establishes left to right vertical alignment of alternating raster lines for stamp mode. Range -20 to +20.
8. **Bed Size:** This is a factory setting that should not ever need to be changed. The wrong bed size will affect your ability to use the entire table.
9. **AirA Raster:** Yes setting activates the air assist when the machine is in raster mode.
10. **AirA Vector:** Yes setting activates the air assist when the machine is in vector mode.
11. **Auto Delete:** Automatically deletes every job after it has finished running if the job is stopped or reset. The factory default is No.

SECTION 6: MINI/HELIX CONTROL PANEL

12. **Sys Units:** Choose between inches and millimeters.
13. **Laser TM:** Activates laser tickle mode. 0 is off, 2 is most commonly used if required. Range is 0 to 3.
14. **Laser TI:** Activates the laser tickle duration. 0 is off, 1 is the most common if used. Range 0 to 3.
15. **M.Control X:** Activates the motor control signal when necessary in the X-axis.
16. **M.Control Y:** Activates the motor control signal when necessary in the Y-axis.
17. **Load FL Job:** Yes displays the jobs that have been saved to permanent memory. Saved jobs will be loaded to the display queue each time you power on your machine. No will hide the permanent jobs and they cannot be accessed until this setting is switched to Yes.
18. **Europe:** If set to yes, European system regulations are implemented in the system.

Speed

During an engraving job or when the laser is idle at Home Position, the speed of the job can be viewed on the control panel by pressing the Speed key. In raster mode you can change the speed on the fly. Speed can only be changed on the fly in raster mode. You cannot change the speed on the fly during vector cutting.



Pressing the Speed key while engraving will change the display to show the speed setting of the job while it is running (see image above). Pressing the Up or Down arrow key will increase or decrease the speed of the carriage. Normally you will need to increase or decrease the speed by 10% or more before you start to notice a visible change in the speed.



Changing the speed on the fly is a useful way to experiment to get just the right speed setting for a material you are not used to engraving. You cannot change the speed on the fly in vector mode.

SECTION 6: MINI/HELIX CONTROL PANEL

Button Functions

Power

During an engraving job or when the laser is idle at Home Position, the power of the job can be viewed on the control panel by pressing the Power key. In raster mode you can change the power on the fly, but you cannot change the power on the fly during vector cutting.

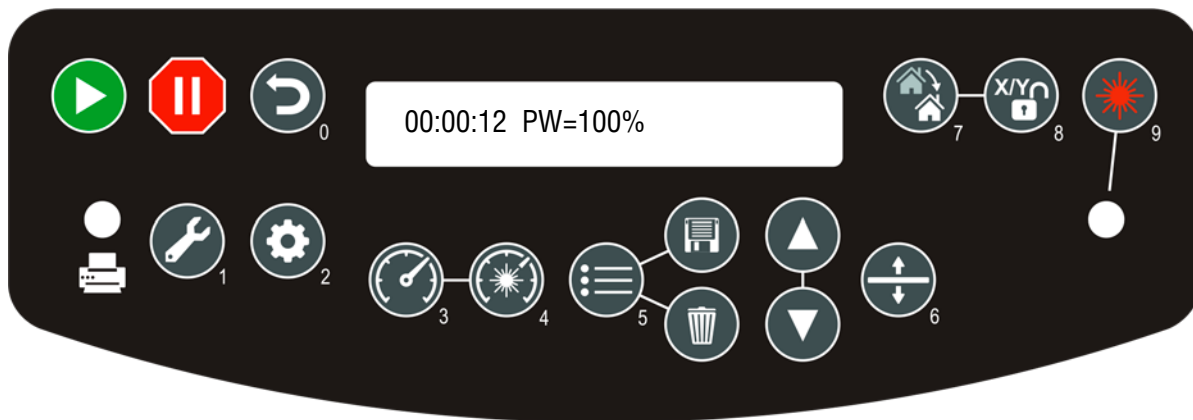

Pressing the power key while engraving will change the display to show the power setting of the job while it is running. Pressing the Up or Down arrow key will increase or decrease the power output of the laser in raster mode. Normally you will need to increase or decrease the power by 10% or more to see a visible change in the laser's speed.

You can also change the power from the laser system when it is in idle mode. To do this, press the Power key, then press the Up or Down arrow keys to change the power. Press Go and job will run at the changed power setting.

Job Save

Pressing the Job Save key will permanently save the job shown on the display into permanent memory. You can save ten jobs of 1 MB or less, or five jobs of 2 MB or less. Saved jobs can be viewed or hidden.

Job Delete

Pressing the Job Delete key will delete the job that is shown on the display. Pressing job delete will delete both permanent and temporary jobs.

Jobs

Pressing the Job key displays the file name of the last job stored in memory. After pressing the Job key, pressing the Up or Down arrows allows the operator to scroll through all of the saved jobs that are stored in the laser system's on-board memory.

SECTION 6: MINI/HELIX CONTROL PANEL

Job Storage: Temporary Memory

You can loop continuously through all of the jobs stored in the laser system. Pressing the go key will start the job that is displayed. The jobs are numbered, so if you send the same job more than once, you will still be able to distinguish it from the other jobs with the same name.

Focus

Pressing the Focus key allows the operator to raise or lower the table by pressing the Up or Down arrow keys. When the Focus key is pressed, the carriage will move out (forward and to the right) several inches (approximately 50 mm) from its standard park position in the upper left corner.



If the table is too high, the carriage may collide with any material that is between the park position and focus position. To prevent the carriage from colliding with your material you can do one of two things:

1. Press the **Pause** key first before pressing the Focus key. Pressing the Pause key immediately before pressing Focus holds the carriage in its park position allowing you to lower the table with your material in place.
2. Remove your material, press the Focus key and use the Down arrow to lower the table.

To manually focus anywhere on the table see the description for the X/Y Off key and Set Home key for a full explanation of this feature.

Job Storage: Temporary Memory

While there is no key for this, the laser has the capability to store multiple jobs in temporary memory. The machine will store any and all jobs sent until there is no free temporary memory left. For all practical purposes, there is no limit to the number of jobs you can send to the laser.



Note: Temporary jobs stored in the laser systems will be erased when the laser system is turned off. For permanent job saving, print the file to the Job Manager, where you can file the job for later retrieval along with all settings you used in the past.

SECTION 7: QUICK START GUIDE

First Test Job

First Test Job

When you have your laser and print driver installed, you are ready to start engraving! To get started quickly and run a sample piece of material on your new laser, the following is a quick setup guide outlining the general steps for running a first job. A detailed set of instructions for each step of the process follows this quick start guide:

1. Find a piece of scrap material to engrave. This might be wood, anodized aluminum or plastic.
2. In your graphic program, create a new page that is the same size as the piece of material you will be engraving.
3. Turn on your laser and wait for a **beep** to note the machine is initialized.
4. Place your sample material on the table in the upper left corner. Make sure the table is low enough to accommodate the material. If not low enough, press the **Focus key**, then the **down arrow** to lower the table before placing your item on the table. Close the door.
5. In your graphic software, **print** the file. Select the laser as your printer.
6. Click Properties to see the Laser Dashboard. Set a resolution (300 or 600 DPI usually), check the box next to **Auto Focus**, set a page size to match the page size of the file, and choose a speed and power setting under raster settings. See “**Epilog Mini / Helix Suggested Material Settings**” on page 143 for suggested speeds and powers.
7. Click **OK** to exit the Laser Dashboard and click **Print** to print the page to your laser.
8. Turn on your exhaust fan or filtration unit.
9. At the laser, the job you sent over will be shown on the LCD display. Press the **Go** key to run the job. The job will start running.

Artwork Setup

When setting up artwork for the laser, you can use most graphic software package of your choice, such as CorelDRAW or Adobe Illustrator. There are three different modes of operation for the laser and the way you setup your artwork will determine if you raster engrave, vector cut, or use combined mode.

Raster Engraving

Raster engraving can best be described as very high resolution dot matrix “printing” with a laser. Raster engraving is used to create highly detailed graphic images. The laser head scans back and forth, left to right, engraving a series of dots one line at a time. As the laser head moves down line by line, the dot pattern forms the image that was printed from your computer. You can raster engrave scanned images, text, clipart, photographs, or line drawings.



This artwork is a good representation of a raster file. The photograph of the tiger will raster engrave, as will the text that has been placed on the page.

Vector Cutting

When you are vector cutting, the laser is following a continuous path that follows the outline, or profile, of an image. Vector cutting is normally used to cut completely through materials such as wood, acrylic, paper, etc. It can also be used for quick marking of characters and geometric patterns. You can vector cut with the laser by setting objects and text to be unfilled and drawn with a 0.001" (0.025 mm) outline. The thin outline will produce a vector cut.

This graphic shows a vector image made up of lines. You can tell it is a vector image because you can individually select any of the lines and manipulate that part of the graphic.



When vector cutting, we always suggest that you use the Vector Cutting Table or Pin Table to protect the back of your material as well as your table from laser marking.



Note: If your raster artwork contains thin lines between .001" (.025 mm) and .007" (.177 mm) depending on resolution, and you are using Vector or Combined mode, those thin lines will all vector cut. The most common setup where this occurs is when you have a clipart image with hidden lines that you send to the laser using Combined mode. The artwork shown below is a good example of a piece of clipart as it appears on the screen (top) and the hidden lines (bottom) that will vector cut if you are in Combined or Vector mode. If you only want to raster engrave, make sure you select Raster mode in the Epilog Dashboard.

In CorelDRAW you can view just the lines (bottom view) by clicking on the **View** key in the menu bar and selecting **Simple Wire Frame**. The upper image is a complex piece of clipart. The lower image shows all of the hidden lines that are in this piece of clipart. If this clipart image were run in Combined mode, it would first raster engrave most of the car then vector cut any of the thin lines below .007" (.177 mm). You can also use the Preview function of the Epilog Job Manager to view only vector lines. See "**Previewing Your Job**" on page 41.

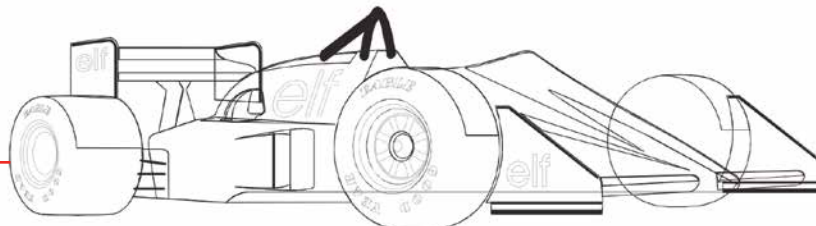

Clipart that looks like it is a raster file is actually often made up of small lines. If the lines are set too thin, then they may cut as well as engrave if you send to the laser in combined mode.

Setting a Vector Cutting Line

The laser determines which lines to engrave or cut based on the width (stroke) of each line. If you're using CorelDRAW, any line set to hairline width will cut. But in other software what width should you set a line to? Different line weights will engrave and cut at different widths and resolutions.

The table below shows various line widths and which will cut at the different resolutions. To be safe, set all vector lines to .004" (.101 mm) or less to make sure they will always cut.

Line Width	150 DPI	200 DPI	300 DPI	400 DPI	600 DPI	1200 DPI
.001" (.025 mm)	Cut	Cut	Cut	Cut	Cut	Cut
.002 (.058 mm)	Cut	Cut	Cut	Cut	Cut	Cut
.003 (.076 mm)	Cut	Cut	Cut	Cut	Cut	Cut
.004 (.101 mm)	Cut	Cut	Cut	Cut	Cut	Cut
.005 (.127 mm)	Cut	Cut	Cut	Engrave	Engrave	Engrave
.006 (.152 mm)	Cut	Cut	Cut	Engrave	Engrave	Engrave
.007 (.177 mm)	Cut	Cut	Engrave	Engrave	Engrave	Engrave

Where do I set the Vector Line Width?

Different software packages set the line width in different places. In CorelDRAW, you can find the outline width in the top menu bar when a vector line is selected. In Adobe Illustrator it is called the stroke width and you can find this setting in the Stroke Panel.



If you can't select a line to set the width, it may be because it is part of a grouped object. Try to ungroup the object, then select the line. You also can't select an individual line if that line is part of a raster image.

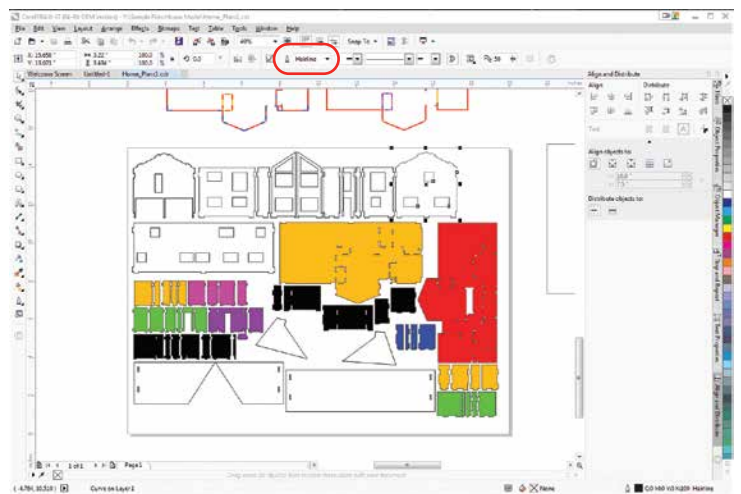

Resolution

Print quality is commonly referred to as Resolution and is one of the variables that determine image quality. Resolution is expressed in dots per inch (DPI) and is determined by the number of lines or dots that are engraved for every inch of movement. Each horizontal line is referred to as a raster line. The higher the resolution setting, the finer the detail that can be achieved. Keep in mind that engraving resolution is only one factor in determining image quality. The quality of the artwork being sent to the laser can have a bigger influence on the look of the final product than the resolution. If low quality artwork is being used, even the highest resolution will not improve it. Also keep in mind that image quality is subjective.

SECTION 7: QUICK START GUIDE

300 DPI may be just fine for some images and some customers, while 600 DPI is the absolute minimum for others.

The diagram below shows the concept of raster lines and dots-per-inch (DPI). The arrows show the change in direction of the carriage between raster lines. The difference in dot density between 300 DPI and 600 DPI.

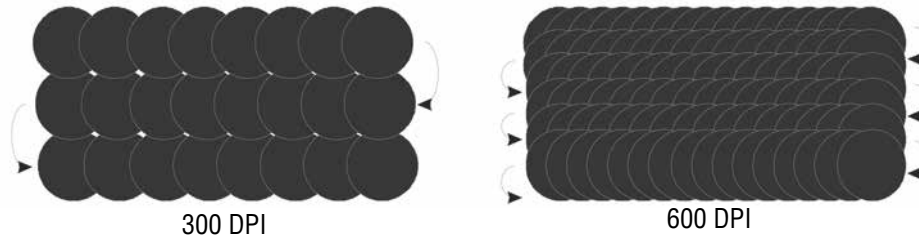

Resolution Settings:

75 – 200 DPI

These resolution values are typically used for non-production purposes where you want to experiment with image location, or if you want to quickly produce a rough draft. Low resolution settings are also useful when engraving products that you don't want to remove too much material while engraving, such as fabric.

300 DPI

300 DPI is useful when engraving materials such as glass, marble, plastic and other items that don't benefit from the engraved dots being close together.

400 DPI

This resolution value is ideal for many applications. It combines very good image quality with fast engraving times. Many users like 400 DPI for all of their work.

600 DPI

When really fine detail or overall excellent results are required, most users choose 600 DPI.

1200 DPI

This resolution is used for projects that require the best engraving quality possible, or if engraving extremely small fonts. Although it's seldom used because, under normal circumstances, most people cannot visually discern the difference between 1200 and 600 DPI. There are some users that appreciate this high level of quality and are willing to take twice as long to produce an image at 1200 DPI as it would take them at 600 DPI.

Helpful Hints

- There are four times as many dots engraved at 600 DPI as there are at 300 DPI. Twice as many horizontally and twice as many vertically.
- The gap between the dots is very small at 600 DPI. At 300 DPI the lesser overlap is responsible for the jagged edges that are visible when engraving at lower resolutions.

SECTION 7: QUICK START GUIDE

- It's important to remember that while resolution plays a part in producing good image quality, the artwork that is sent to be engraved is just as important. If the artwork that is sent to the laser is poor quality, trying to engrave it at 600 DPI will not improve the quality. It's always best to start with high resolution images. Poor artwork will probably always look poor at any resolution, while good artwork will look good at any resolution.
- Twice as many dots and twice as many lines at 600 DPI produces a much deeper burn into materials like wood than you would see engraving the same image at 300 DPI. This is important to understand because depth of burn is closely associated with engraving resolution – the higher the resolution, the greater the depth of burn for a given speed. The relationship between resolution, depth of engraving and Speed and Power setting is something that most people figure out with just a little experience. “**Appendix B: Material Settings**” on page 143 helps to make this easy to understand by providing different Speed and Power settings and suggested engraving resolutions for each different material listed.

The photos below show a clipart image engraved at 300 DPI (top) and at 600 DPI (bottom). This clipart image is full of different shades of gray and you can see that the dot spacing is spread out more on the 300 DPI than it is on the 600 DPI. Just changing the resolution to 600 DPI produces so much dot overlap that the fill patterns tend to blend together. It's a matter of personal preference as to which resolution looks better, but these photos show the dramatic difference resolution can make, especially when engraving with grayscale images.

300 DPI

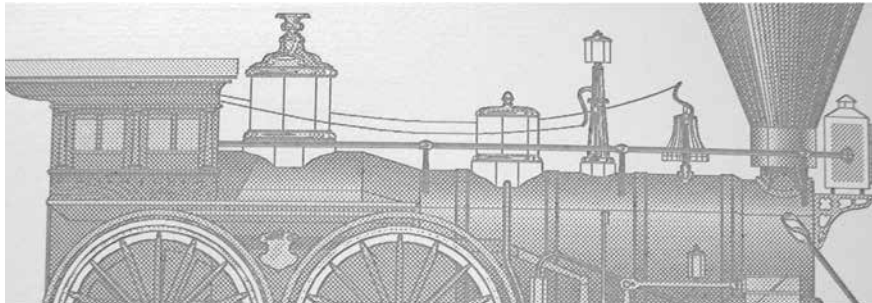

600 DPI

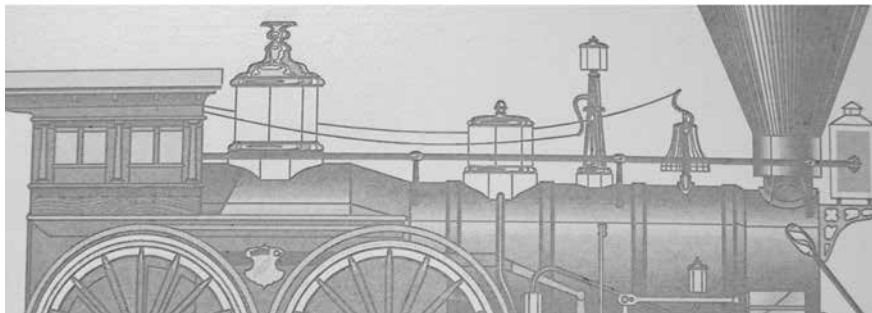

SECTION 7: QUICK START GUIDE

Landscape or Portrait

Landscape or Portrait



You can engrave using either landscape or portrait modes. Depending on the artwork, you can increase your efficiency and decrease the time it takes to engrave an image by changing the orientation of your file. Many users set up their artwork in portrait mode and then rotate the artwork 90 degrees if they are going to print from landscape mode.

This project setup shows the same job in portrait mode (left) and landscape mode (right). The landscape mode will engrave quicker because there is less turnaround time as the laser makes longer passes across the engraving table. For example, at 100% speed and 100% power in portrait mode this graphic will take 56 minutes, 56 seconds, while in landscape mode it takes 38 minutes, 54 seconds, a 34% time savings.

Engraving Time: 56:56

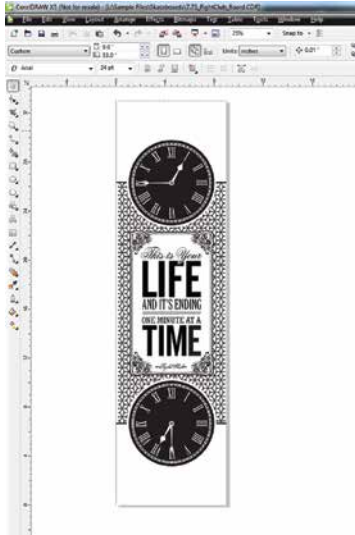

Engraving Time: 38:54

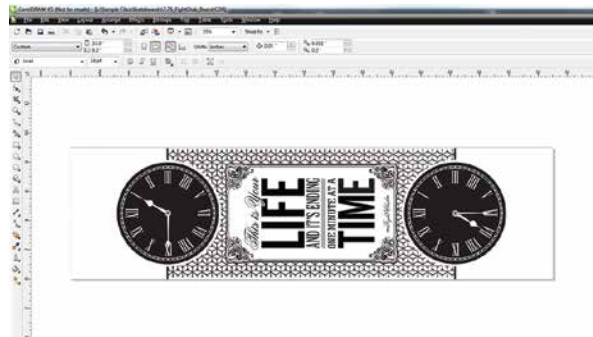

The drawings below show a job that works in the opposite way - the horizontal mode will take longer than the portrait mode. You'll notice in the portrait mode there are a number of white space lines that the laser can skip through, saving engraving time. In the landscape mode there is not white space for the laser to recognize as it moves down the page, taking the engraving time from 10:12 to 17:14. Experiment with the artwork that you use. It will quickly become second nature which mode works best for different types of artwork.

Engraving Time: 10:12

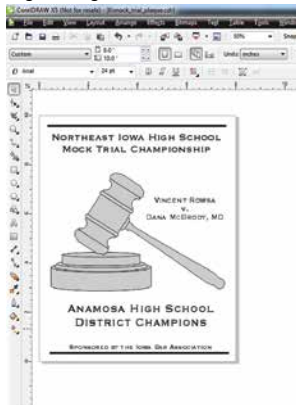

Engraving Time: 17:14

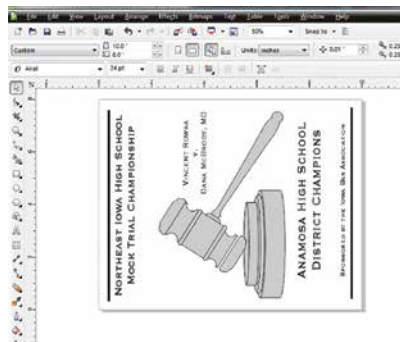

A third consideration for landscape or portrait art setup is material specific. Some materials, such as wood or plastics that have a grain or brushed look, will look better when engraved if the grain of the material runs parallel with the X-stroke of the carriage. While the orientation of material without a grain pattern is usually not important, it is important to keep this in mind with woods that have a stronger grain pattern.

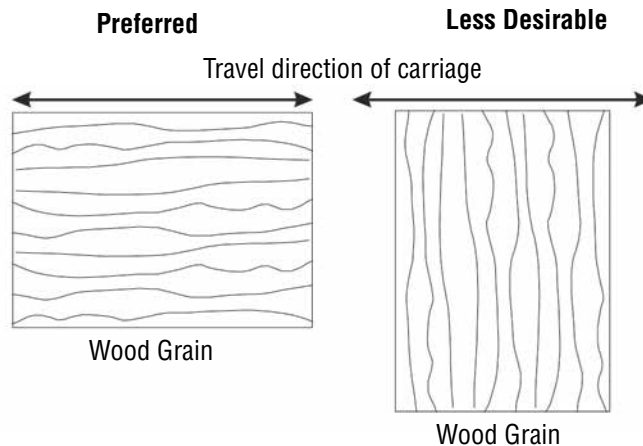

Piece and Page Size

Many users like to create their artwork on a page size that matches the size of the piece that is to be lasered. Compensating for beveled edges or placing an image in an exact location is easy when there is a one-for-one relationship between the material and the page size of the artwork. If this method works for you, remember that you must also set the Piece Size dimensions in the Laser Dashboard to match the page size you have set in your graphics software.

On the other hand, many users do not want to change the Piece Size dimensions in the Dashboard every time they print something new. They prefer to use a page size that matches the table size and place their artwork into the upper left corner of the page. Both methods are effective and it is a matter of personal preference which method is used.

Place the material to be engraved on the engraving table in the upper left hand corner, pressing the material firmly against the metal rulers along the top and left edges.

Most material does not need to be held or clamped in place. Simply setting it on the table and letting gravity hold it in place is enough. If you are using a material that is likely to move during operation or is very thin, you can hold it in place using the Epilog Integrated Vacuum Table. Simply place it on the table flush against the upper left hand rulers, then cover any remaining holes in the metal table with scrap material or a jig. This will create a semi-suction and hold the piece of material in place. The material can also be held with a variety of materials such as masking tape, clay, magnets, etc. Creating jigs is also an excellent method of holding materials that are high volume, or high value. Engraving or cutting a jig to match an unusual shape is very easy to do with the laser from scrap wood, acrylic or even cardboard.

SECTION 8: CLEANING & MAINTENANCE

Reduce Fire Risk with a Clean Laser

Reduce Fire Risk with a Clean Laser



Cleaning the laser is an excellent way to prevent fire with the laser. A buildup of cutting and engraving residue and debris is dangerous and can create a fire hazard in its own right. Keep your laser system clean and free of debris. Regularly remove the Vector Cutting Table to clean any small pieces that have fallen through the grid.

For more information on fire safety, see “Fire Warning” on page 5.

Cleaning the Auto Focus Plunger

The plunger for the Auto Focus assembly is mounted at the back of the carriage that holds the focus lens. The bottom of the shaft needs to be cleaned periodically for accurate focusing. Use a cotton rag and some mild household cleaner (Windex, 409, or Isopropyl Alcohol) to remove buildup from the plunger.



Plunger

Cleaning the Optics

About once a week, or if you notice dust building up, you will need to clean the optics (mirrors and lenses) of your laser. If smoke, resin, or other contaminants are allowed to accumulate they will reduce the available laser power and may cause damage to the optics.



Mirror

Focus Lens

The two optical components most likely to require cleaning are the focus lens and the mirror directly above it. The lens and mirror are a single assembly and can be removed from the machine for cleaning, but it is generally not necessary. If you need to remove the assembly for a more complete cleaning, remove the two 3/32” hex screws that hold the lens to the carriage.

To clean the optics, use a high-quality cotton swab moistened with the optics cleaner supplied in the accessory kit. Please read the label on the bottle carefully.

If you run out of the cleaner supplied by Epilog, Reagent or laboratory grade Alcohol can be substituted. Also, if “Golden Grain” or “Everclear” are available in your area these are also good substitutes for the optical cleaning solution.



Never use Isopropyl Alcohol, Acetone, or water. They contain impurities which can damage the optics in your machine.

Wet the swab thoroughly with the solvent, and then blot it against a piece of cotton so that it is no longer soaking-wet. Then daub the optic gently, rotating the swab after each daub to expose clean cotton to the surface until the optic is free

SECTION 8: CLEANING & MAINTENANCE

Cleaning the Optical Strip and Encoder

of visible contamination. At that point, prepare a fresh swab and clean the surface with a gentle zigzag motion across it. Avoid any hard “scrubbing” of the surface, especially while there are visible particles on it, and try not to use repetitive circular motions. When you are done, be careful to remove any cotton threads that may have snagged on the mountings. Allow the optics to dry before you operate your engraver.

In addition to the focus lens and the mirror directly above it, there is a mirror located on the left side of the laser system and is mounted to the X-beam.

This mirror is very well protected and should not need regular cleaning. It can be accessed with a cotton swab if it does need cleaning.

2nd Focus Lens

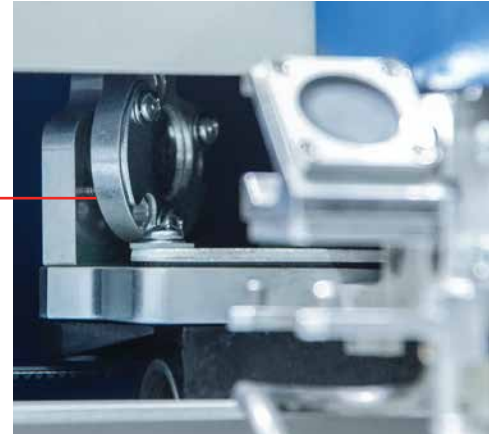

Cleaning the Optical Strip and Encoder

If you engrave a lot of material that generates dust and debris, this can build up over time and prevent the optical encoder from working properly. Occasionally you may need to clean the optical encoder strip and the reader assembly. These are located under the protective cover of the X-axis assembly. The optical encoder provides precise positioning for the X-carriage. If the encoder reader or encoder strip gets dirty, the X-axis can lose position. If the X-axis carriage loses position, it is just a matter of removing the X-beam's protective cover and wiping off the optical encoder strip using a soft cotton cloth or cotton swab soaked in distilled water or a mild dish washing soap.

To remove the X-beam cover, turn off the laser and loosen the two screws in front of the cover and five in the rear of the cover. You do not need to remove the screws - they just need to be loosened to remove the cover. Lift the cover from the beam to expose the optical encoder and the optical strip.



SECTION 8: CLEANING & MAINTENANCE

The optical strip is a thin, clear piece of plastic that has very thin, small vertical lines on it. The strip runs the length of the X-beam from left to right. The cotton swab is shown on the rear side of the strip.

To clean, soak a cotton swab or cloth in distilled water and move the swab across the front and back of the optical strip along the entire length of the strip. A diluted mild dish soap can also be used to remove debris that water alone does not remove. Repeat with a second, clean swab with distilled water.



The encoder reader is a horseshoe shaped device that straddles the encoder strip. There is a possibility that dirt and debris can get inside the encoder. Blow some compressed air under the encoder to remove any dust and debris.

Canned air like this is used for cleaning keyboards, but be very careful not to tip the can so that liquid is not sprayed from the can. The liquid coming from the canned air can damage the encoder reader.

Use gentle pressure when cleaning the optical encoder reader and strip. They are not easily damaged, but the use of excessive force or sharp tools could damage either device. Do not disassemble anything other than removing the cover from the X-beam. Replace the cover once the encoder strip and encoder have been cleaned.

Cleaning and Lubricating the Bearing Rails

Clean the X-axis Bearing Rail

Use a soft cloth or cotton swab with some alcohol or similar mild solvent to clean each of the bearing tracks which the optics (mirror and lens) run along. A cotton swab is perfect for cleaning out the inside of the grooved tracks of the X-axis rail.

Use a soft cotton cloth or cotton swab to clean the entire length of the X-axis rail.

This photo shows a cotton swab cleaning out the top groove of the X-axis rail. There is another groove on the bottom side of the rail. You will need to move the X-axis belt out of the way to access the rail. There is enough flex in the belt to move it out of the way, but do not pull on it so hard that it becomes stretched or stressed.



SECTION 8: CLEANING & MAINTENANCE

Cleaning and Lubricating the Bearing Rails

Lubricate the X-axis Bearing Rail

After cleaning the rail, place about an inch long bead of Epilog supplied grease into the top and bottom grooves of the X-axis rail. The following photo shows where to grease the bottom groove of the rail.

After applying the grease to both grooves, run the X-carriage over the grease to work it into the bearing block and rail. Turn the machine off to easily move the X-carriage back and forth over the grease.



Clean the Right Side Y-Axis Rail

Clean the length of the right side Y-axis rail using a soft cotton cloth. Lubrication is not required.

○ Clean the right side Y-axis rail with a soft cloth.

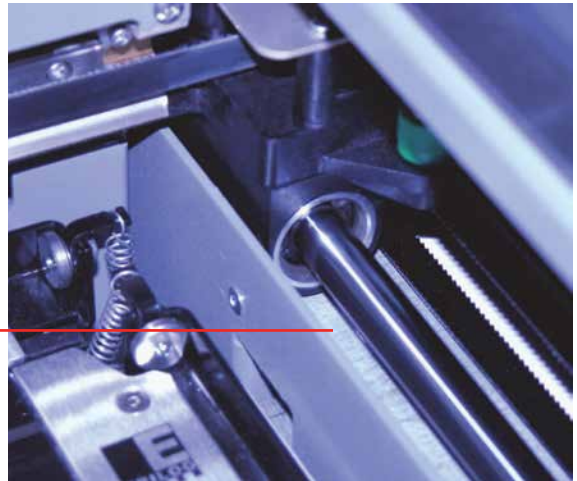

Clean the Left Side Y-Axis Rail

Clean the length of the left side Y-axis rail using a soft cotton cloth. Lubrication is not required.

After cleaning the rails and bearings, clean off the table and the rest of the inside of the machine. Spending just a few minutes a week will pay off in the long run with better quality and performance.

○ The left side Y-axis rail should also be wiped with a soft cloth.

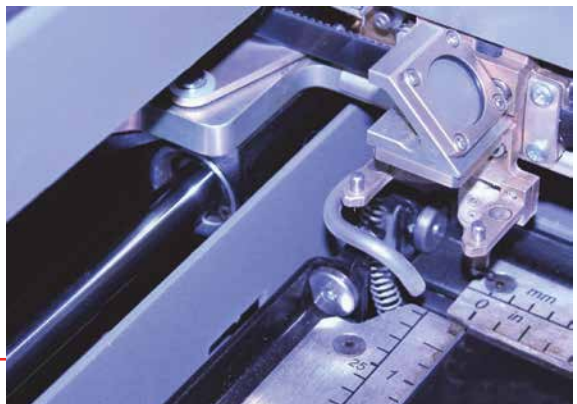

After cleaning the rails and bearings, clean off the table and the rest of the inside of the machine. Spending just a few minutes a week will pay

SECTION 8: CLEANING & MAINTENANCE



off in the long run with better quality and performance.

Crumb Tray Cleaning

The Crumb Tray is located below the Vector Cutting Table and collects small debris that falls through the table when vector cutting. Open the front access door of the laser and slide the crumb tray out of the front of the machine to keep it clean.

This photo shows the crumb tray partially removed. Dispose of all debris on the tray.



Always keep the table tray clean! Remove all debris that has fallen through the Vector Cutting Table. Debris and soot build up in the tray create a dangerous fire hazard over time.



Exhaust Cleaning

Cleaning the Vents

Clean the vents from the inside of the machine. It is best to use a flexible plastic or wire brush that can access the inside of the vent.

Clean the vents with a brush.



Cleaning the Down Draft Ports

In addition to the top vents, also clean the down draft ports.

The down-draft ports are located on the black strips at the back of the machine.



Cleaning the Rear Exhaust Port

Periodically remove the duct from the back of the machine and clean both exhaust ports. Inspect and clean your exhaust fan and duct work that it to which it is connected.



Laser Tube

The laser tube used in your system does have a maximum service life, and there is very little maintenance that is required. At some point in the life of the laser you will need to replace it for gas recharge, electrical repair or mechanical repair. Replacing laser tubes is common practice and Epilog has made the process of changing tubes extremely easy for users to perform with a minimum amount of effort. The laser tubes can be refurbished and are available on an exchange basis by contacting Epilog technical support.

Ensure that all of the laser cooling fans are properly working at all times. The fans keep the laser tube cool and prevent it from overheating. An overheated laser tube will produce erratic output and may fail completely.

If the laser system is in a dirty or dusty environment, make sure that the cooling fins on the laser tube are kept free of dust buildup. Use compressed air to blow the dust and debris off of the laser tube fins. Be sure that the system is unplugged before performing any maintenance on the machine!

SECTION 9: SYSTEM FEATURES

Air Assist

The Air Assist feature on the laser system is used to keep combustible gases away from the cutting surface and to reduce flare-ups of more flammable materials - such as wood and acrylic - as you cut through it.

The Air Assist directs a constant stream of compressed air across the material surface at the point of burn removing the heat and combustible gases from the work surface. The constant air stream helps reduce charring and scorching associated with materials, such as wood, rubber, and acrylic.

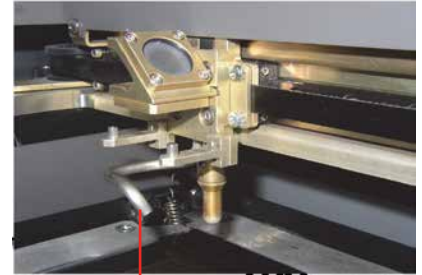

Air Assist Tube



The Epilog Mini and Helix have been pre-plumbed for Air Assist so that all you need to do is to attach a small compressor pump to the back of the machine. The pump can either be purchased through your Epilog representative or you can connect your existing compressed air supply to the 0.25" (6 mm) receptacle at the back of the machine (30 PSI max).

Air assist should always be activated during vector cutting operations to reduce the risk of fire! For more information, see **"Fire Warning"** on page 1.

Auto Focus vs. Manual Focus

In order to engrave or cut a crisp, clean image, your material must be the correct distance from the bottom of the focus lens. Setting the distance from the bottom of the focus lens to the top of your material is the process of focusing, and is accomplished by placing your material on the table and moving the table up or down. There are two different methods of focusing: Manual or Auto Focus.

Manual Focus

The photo below shows the "V" shaped manual focus gauge that is used to determine the correct distance from the focus lens to the top of your material. This gauge is included in the Accessories Kit that comes with your system.

Place the manual focus gauge on the carriage and place the object to be cut or engraved in the upper left corner of the machine. Press **Focus** on the keypad, then use the Up and Down Arrows to move the table to the correct height. Once the focus position has been established, remove the gauge. Press the **Reset** key.



If your material has a taper or curve, pick an intermediate point between the highest and lowest points being engraved and focus on that point. In general, the area of the material being engraved needs to be relatively flat. If the area being engraved differs in height by more than about an .125" (3 mm), the image will begin to look "fuzzy" or out of focus.

SECTION 9: SYSTEM FEATURES



When you press the Focus key, the laser carriage will move out and away from the edge of the table. To prevent the carriage from moving out before focusing, press the **Pause** key first before pressing the Focus key. The laser carriage will remain in the parked position, allowing you to use the Up and Down Arrows to move the table to the correct focus height.

Manually Focus Anywhere on the Table: If you wish to focus at a point on the table other than in the upper left corner, you can do so by disabling the axes and moving the carriage by hand to the location where you would like to focus. Press the **X/Y Off** key, then the **Go** key. This disables the X and Y axes and you can now move the carriage by hand to any point on the table. Press the Up or Down cursor keys on the keyboard to move the table to the proper focus height. After you have focused, press the **Reset** key to send the carriage back to its park position. This process also works with the Rotary Attachment.

Auto Focus

The Auto Focus takes the guesswork out of focusing the job to the right height. It works on any solid surface, including transparent materials, such as glass and acrylic, and also works with the Rotary Attachment. Focus is determined at the first point of engraving or cutting to ensure precise focus.

The Auto Focus uses a plunger that is attached to the carriage to determine correct focus position. When the Auto Focus is activated, the engraving table moves up until the work piece pushes the plunger up. The table then moves down until the work piece is in precise focal position.

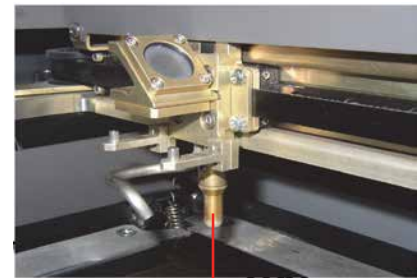

Auto Focus Plunger



Be careful when using the Auto Focus on uneven or irregularly-shaped items. The plunger must clear all edges of the work piece or you may cause damage.

Activating the Auto Focus can be done on your computer by checking the **Auto Focus box** in the dashboard (see “**Auto Focus**” on page 46.) If there is not a check in this box, Auto Focus will be disabled and the table will not move up or down when the job starts.



If you are using Auto Focus and you know there is not enough clearance between the lens carriage and your material, you will need to lower the table before you insert your material and start the job. To lower the table, press the **Focus** key on the Control Panel then use the **arrow keys** to lower the table.

Image Dithering

Dithering defines how the dot patterns will be engraved in raster images that contain grayscale graphics, blends, or color images. The Dashboard offers six different dithering patterns to enhance your engraving projects. The default mode is Standard. This mode can be used for all images including photographs. Dithering is used only for raster engraving and has no effect on vector cut lines.



Laser engraved photographs on wood usually require a third party software package to produce a good image that is suitable for the laser. Epilog recommends **PhotoLaser Plus** for this application. Users find it to be an extremely valuable piece of software that is easy to use and will produce much better looking images when working with wood. Please contact your Epilog representative to learn more about this software package.

What is Dithering?

The best way to show dithering is to look at the exact same photo engraved in Standard mode and Stucki mode. Both photos were engraved at 300 DPI. With the two different dithering patterns you achieve a very different result, with a more structured pattern for the Standard mode, while the Stucki mode results in a more random pattern that looks more natural and pleasing to the eye.



300 DPI Standard Mode



300 DPI Stucki Mode

Dithering is a great way to enhance your engraved products, but it is very material dependent. A dithering pattern that looks good on marble might look very different when engraved on plastic. Give yourself some time to experiment with the different dithering patterns. It's easy to do and once you have a feel for it, you will be able to use it with confidence.

The drop-down list of dithering patterns is easier to think about if you separate the six options into two categories that we will refer to as Clipart and Photograph:

Clipart Modes

- **Standard:** This mode is the default mode and will be used for most engraving jobs that include text and clipart at 600 DPI.

- **Brighten:** This lightens the clipart, and some users also find this mode good for engraving photographs onto wood or marble at 600 DPI.
- **Low Res:** Adds an artistic half-tone type look to the engraving which sometimes helps when engraving low-resolution photos.

Photograph Modes:

- **Floyd-Steinberg:** Produces an almost wave-like pattern to an image. This works well for some photos containing a great deal of detail. Photos with more monotone swatches of color may not be as pleasing as Jarvis or Stucki modes.
- **Jarvis:** Many users find this mode good for engraving photographs at 300 DPI. This mode produces a very nice looking pattern on almost all photos.
- **Stucki:** This mode produces results that are only marginally different than the Jarvis dithering pattern. It is also very good for engraving photographs at 300 DPI. The differences between Jarvis and Stucki are very subtle.

Experiment with the different dithering patterns to determine which effect is most pleasing. It is not mandatory that you use the clipart modes with only clipart images or photograph modes with all photographs. Many users prefer one of the photograph modes for many clipart images, and one of the clipart modes for photographs. The choice is entirely up to you and will take some experimentation.



We have included some sample photographs on the Epilog driver disc for you to experiment with. Use these photographs to engrave on different materials using the different dithering options so you can get a feel for how each dithering pattern affects the image and the material.

Color Mapping

The Color Mapping feature is an advanced feature that allows you to set different engraving and cutting settings to different colors within your artwork, and can be used in both raster and vector modes. The functions that can be controlled by color are: Speed, Power, Frequency, Raster On/Off, Vector On/Off and Air Assist On/Off. While Color Mapping is a very powerful tool, most users use it for two main reasons:

1. Using different colors to engrave at different speeds and powers within one document.
2. Using different colors to allow users the ability to sequence the order that objects will be marked.

Using Color Mapping



1 Enable Color Mapping

When this check box is selected, the laser will use the settings assigned to each color. For any colors that are in your artwork, but not in the color mapping settings, the General settings will be used.

2 Adjust Settings

Use the slider bars to set any RGB color and create the laser parameters. Adjusting the settings does not actually change the values until you have finalized the settings by selecting the **Right Arrow** key.

3 Color Map Summary

The Color Map Summary area is located on the right side of the window and offers a visual display of all of the color mapped settings.

1. To use Color Mapping, start by enabling the Color Mapping section by **clicking the check box** in the upper left corner of the screen.
2. **Select a color** in the Summary area. We selected the color Red.
3. **Adjust the laser settings** in the Settings area.

4. Once the laser values have been adjusted, press the **Modify key** in the Settings area. The available keys are:



Add a Color



Modify a Color



Delete a Color



Move Color Up in List



Move Color Down in List

5. You'll see that in the Summary area, the new settings assigned to the color red are now displayed.

Color Mapping Functions

Speed: Applies a speed setting for all objects of the same color.

Power: Applies a power setting for all objects of the same color.

Freq: Applies a frequency setting for all objects of the same color.

Raster: With this box checked, all raster objects set to that color will be processed at the color mapped settings; however, this function will still not allow a vector line set to a Vector stroke width to engrave.

Vector: With this box checked, all vector objects set to that color will be processed at the color mapped settings; however, this function will still not allow a raster object to be processed as a vector.

Air Assist: With this box checked, all objects will be processed with Air Assist turned on.

Using Color Mapping for Multiple Speed and Power Settings

A fairly typical use for vector color mapping is in the architectural industry and making models. Users want to lightly mark one part of the work piece and cut out another part of the same piece.

Usually, when using Color Mapping in Vector mode, users want to produce a different look on two separate areas of a single piece of material in a single job setup. To achieve a different look for each mark the marking processes require different speeds and powers so this is a perfect job for Color Mapping.



Note: While you could set the vector line you want to just mark to an engraving width, it takes much longer to engrave a box than to use vector settings to quickly follow the line and mark it.

The graphic shows a simple architectural drawing. The drawing is set up so that when we use Color Mapping, we will assign one speed and power setting to first lightly engrave the window frames and a different speed and power setting to then cut out the individual window panes.

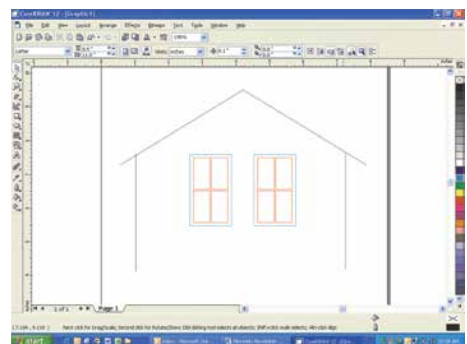

SECTION 9: SYSTEM FEATURES

The outside frame of the house will not be Color Mapped since it is not a color that has been assigned in the Color Mapping Summary area. **That line and any other lines that are not a color mapped color will be processed at the speed and power settings that are set in the General Tab of the Dashboard.**

We have assigned the window frame vector line to the RGB green color, and the window panes to RGB red. You **MUST** use an RGB color scheme in your artwork with the Color Mapping feature. **CMYK values will not translate.**

It's best to use one of the six basic colors (red, green, blue, cyan, yellow, magenta) when color mapping, because the values in Color Mapping **must match exactly** the colors that are used in your graphics package. The RGB color scheme uses numbers to define all colors and the six basic colors have the following numerical definitions:

Color	Red Color Value	Green Color Value	Blue Color Value
Red	255	0	0
Green	0	255	0
Blue	0	0	255
Cyan	0	255	255
Yellow	255	255	0
Magenta	255	0	255



A CMYK palette will not work! The six basic colors are easiest to use because they only use combinations of 255 and 0 (255 is the highest number value and 0 is the lowest in the RGB color scheme). Because all graphics packages use the six basic colors, this is easy to do. The Laser Dashboard loads the six primary colors as presets for your convenience. Any color can be added or deleted to meet your needs. Once your vector outlines are set up in your artwork, Select **File/Print** and go to the **Color Mapping Tab** in the Laser Dashboard.

6. Make sure **Color Mapping is checked** so we can set up our color mapping settings.

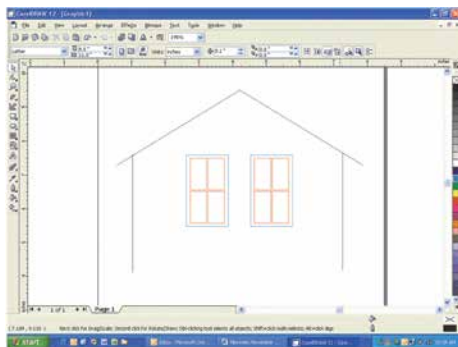

7. In our example we want to mark the green window frames first, so green must be the first color at the top of the list. Normally the color green is the second color down in the list. In order to move it we just select it and press the **Up key** to move it up one position. We now have green at the top and red is the second color down. This is the order in which the colors will be processed.
8. With the green color selected in the summary, we set a higher speed and lower power (50% speed, 10% power) to just mark the top of the piece. When you have your settings as you'd like them, click the **Modify key**.



- Repeat by selecting the Red color in the summary area, then adjusting the speed to 20% and power to 100%, then clicking the **Modify** key.

Using Color Mapping to Adjust Object Order

Another popular use for color mapping is to adjust the order a series of objects engraved or cut. In this example there are three columns of names we are engraving. If we engrave the left file in the image below, the laser carriage will have to travel all the way across the table, covering a lot of empty space, to engrave the image.



If we adjust the colors in each bar, we can setup the color mapping to engrave first the red bar, then the green bars in the center, and finally engrave the blue bar on the right side of the page. The engraving time drops from 39:09 to just 22:14 by using Color Mapping in the file setup.

Engraving Time: 39:09

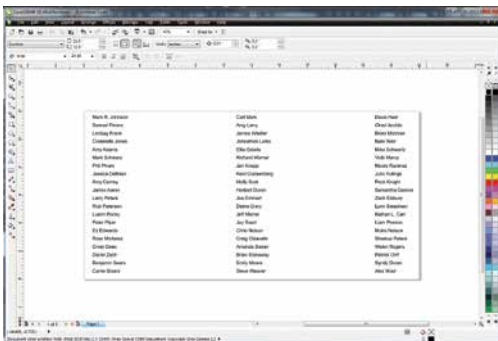

Engraving Time: 22:14

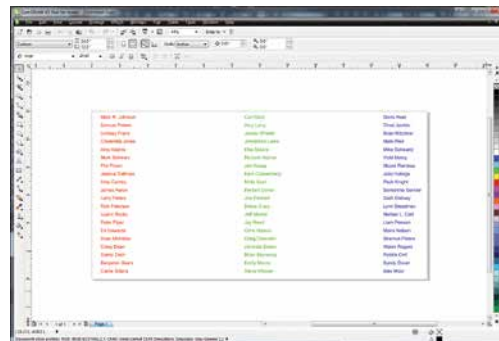

Additional Color Mapping Notes

- When color mapping is used, it always starts from the top color in the Map List and then descends through the remaining colors.
- There's one important distinction to recognize about how colors are raster engraved in standard engraving mode vs. Color Mapping mode. In standard engraving mode different colors are interpreted as different shades of gray that will produce different fill patterns when engraved. In Raster Color Mapping mode all of the different colors are engraved as if they have a black fill. There is no way for a color to produce both a fill pattern and be color mapped at the same time.

Non-Mapped Colors

Non-mapped colors will be processed last and will be processed using the Speed and Power settings from the General Tab. An example would be artwork that has black lines as well as the red and green we are mapping. The black lines will be processed last at the speeds and powers that are set in the General Tab.

Color Mapping in Combined Mode

Color Mapping in combined mode requires a little more planning than Raster-only or Vector-only modes.

1. Any object that is color mapped will be raster engraved first in the order the colors appear in the Summary section of the tab. Any other raster objects that are not color mapped will then be raster engraved using the raster settings found in the General Tab.
2. After all of the raster objects have all been engraved, the vector objects will be cut in the order they appear in the Summary section of the tab. Any other vector objects that are not color mapped will then be vectored using the vector settings found in the General Tab.

For most jobs, Color Mapping is a powerful and easy tool to use and understand. Please keep in mind that because you can control seven different variables and 17 different colors doesn't mean that you should. With so many different settings available in a single setup it has the potential to get overly complicated. Sometimes it's easier to scale back on how many colors a job should use.

Reset Home Position

To reset your Home Position, on the Control Panel and select the **Maint** key. Press the **down arrow** to see **1. Restore Home**. Press the **Go** key and the Home Position will be restored.

Red Dot Pointer

The Red Dot Pointer is a visible laser beam that runs in the same line as the invisible CO2 laser beam. The Red Dot Pointer serves several purposes on the laser, and will become one of your favorite features of your laser system. It is activated by pressing the **Pointer** key on the display panel.

Set a New Home Position

Use the Red Dot Pointer to set a new Home Position by pressing the **X/Y Off** key, then **Go**. Move the laser to the new Home Position by hand and set a new Home Position by pressing the **Go** key.



When the laser is “parked” at the top-left corner, the Red Dot Pointer will not be at the 0,0 Home Position. It is moved slightly down and to the right. **You do not need to adjust the home position.**

Park Position



Position Your Artwork



This is a popular use for the Red Dot Pointer and is one of the easiest ways to make sure each project you run is going to engrave or cut in the correct position. **Learn this easy task and use it!**

1. For a visual representation of the engraving area on a project, create a box around your engraving area with a stroke width of .001" (.025 mm).
2. On the General Tab, set a vector setting of 0% power. **With the door of the laser raised so the laser won't fire**, run the job. The Red Dot Pointer will outline the area where the job will run, so you can make sure that you have the correct positioning before running any job. (Setting the power to 0% will also protect you in case you forget to leave the door open).
3. Now you can reposition the artwork, or the piece you are engraving, so you have a perfectly placed engraving project.

Movable Home Position

When engraving irregularly-shaped objects, Epilog's movable Home Position feature will quickly become one of your favorites. You can simply set a new Home Position display panel on the Mini or Helix Laser.

Setting a new Home Position has never been quicker or easier. Let's say you're engraving on a custom acrylic award that won't quite fit in the upper left corner of the work area. By moving the award out into the center of the table and setting a new Home Position at the upper left corner of the award, you can rest assured that your engraving will be placed accurately on your engraving piece every time in a few easy steps.

1. Start by turning on the Red Dot Pointer at the Control Panel by pressing the **Pointer** key.
2. Press the **X/Y Off key**, then the **Go key**.
3. You can now move the laser carriage by hand. Using the Red Dot Pointer as a visual reference point, move the carriage until you have positioned the pointer above your new Home Position.
4. Press the **Set Home** key.
5. Your new Home Position has been set. When you are done and want to reset your Home Position, press the **Maint key**, then press the down arrow once until you see **1. Restore Home**. Press the **Go key** and the carriage will move back to the original Home Position.

Center Engraving

The Center Engraving feature allows you to define the center of your artwork as the primary reference point (Home Position) of your engraving or cutting. The Center Engraving feature has been designed to be used in conjunction with the Set Home feature of the laser. Center engraving differs from standard printing where the upper left corner of the page and the upper left corner of the laser table define your primary reference point. To see where to set Center Engraving in the driver, see “Center Engraving” on page 46.

- You can identify a Center Engraving job at the laser when you see an asterisk at the end of the job name.
- If you get a Position Error reading on the display screen, your artwork is going to go outside of your available work space.
- There are four choices for Center Engraving: Center-Center, Left-Center, Top-Center and Page-Center.

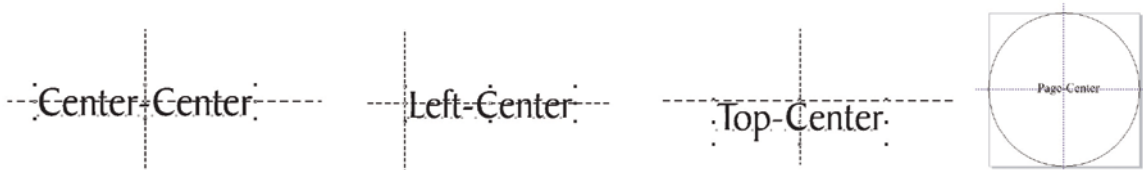

Center-Center

When using Center-Center, the overall size of your work piece and the upper-left corner reference point are not important. With Center-Center engraving the important starting points are the size of your artwork and the available space for it on your work piece. With Center-Center you're interested in positioning the center of your artwork to a specific point on your work piece, no matter where your work piece is on the laser table. When using Center-Center you can place your artwork on almost any size of page and almost anywhere on that page.

The detailed examples on the next few pages show how easy it is to think differently about Center-Center jobs.

Example: A customer brings you a small electronic item to engrave, such as an iPhone. To quickly engrave the item without extensive measuring, follow these quick steps:

1. Measure the area you have available for engraving. For the iPhone we have about 2" x 1.5" (51 x 38 mm) of engraving area.
2. In your graphic software, create a new page. Page size is not important, so set the page size to larger than the area you want to engrave. We have created a page 4" x 4" (101 x 101 mm). Place your image anywhere on the page and size it to fit in the 2" x 1.5" (51 x 38 mm) engraving area.
3. To ensure the graphic is correctly positioned, draw a vector box around your artwork with a vector cutting stroke width (.001" or .025 mm). **Print** the box to the laser.
4. Click the check box next to **Center Engraving** in the General Tab of the driver.



SECTION 9: SYSTEM FEATURES

5. In the drop-down box, select **Center-Center**.
6. Set the page size to match the page size in the Laser Dashboard (4" x 4" or 101 x 101 mm).
7. Select **Vector** as your job type.
8. Set a **Vector Power Setting of 0%** and print the job to the laser.
9. **Run the job with the laser door open** (so the laser won't fire). If the engraving area is lined up, delete the outline you created and print the engraving job to the laser.
10. After the job is complete, you can reset the Home Position by pr the **Maint key**, then press the down arrow once until you see **1. Restore Home**. Press the **Go key** and the carriage will move back to the original Home Position.

While Center-Center is the most common use for the Center Engraving features you can also use **Center-Left** and set a Home Position that is the left portion of your engraving area. **Center-Top** is at the middle, top area of the area you want to engrave. Depending on the object you are engraving, this may be easier to find than the center point of the engraving area.

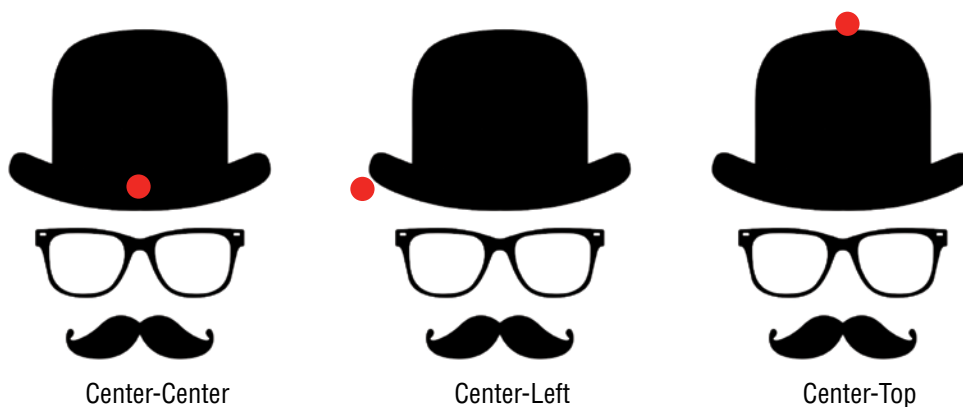

Center-Center

Center-Left

Center-Top

The red circle signifies the Home Position for each Center Engraving choice.

Page-Center

When you are engraving an unbalanced image (not equal left to right or top to bottom), you will want to use the Page-Center feature. For this example, if we engrave the image with Center-Center settings, the graphic will not look centered on the object because the actual center point is to the right of the point we want to center in the logo. To get around this, we'll use Page-Center.

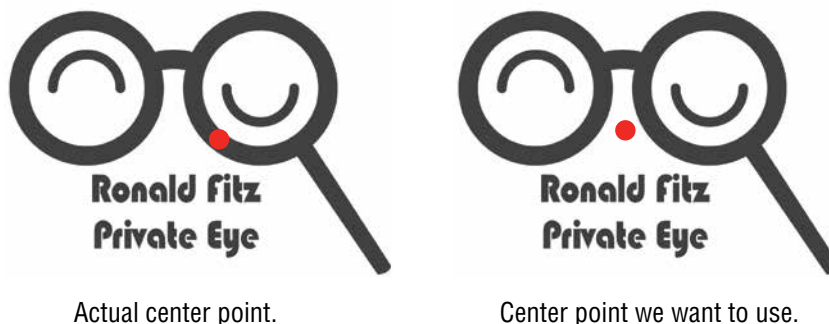

Actual center point.

Center point we want to use.

SECTION 9: SYSTEM FEATURES

1. **Set the page size** to the area you want to engrave. Unlike when we used Center-Center, **page size is important when using Page-Center**.
2. **Center** your graphic on the page with the center point you want to use (the image on the right).
3. In the Laser Dashboard, check the box next to **Center Engraving** in the General Tab, then select **Page-Center** from the drop-down box. **Set the piece size** to the size of the page you created.
4. Set the Home Position as the center of the object you are engraving using the steps in the previous example.
5. Run the job and you'll have a perfectly centered image.

Front Access Door

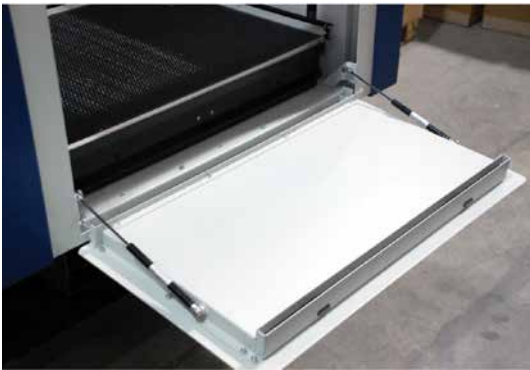

The front access door is usually used for easy loading and unloading of palletized materials. The door is interlocked and the laser will not fire if the door is open.

The front access door is supported by struts. The struts can be disconnected if you wish to open the door more than the standard 90 degree opening. Remove the left and right thumb screws to allow the door to open the full 180 degrees.

Task Plate

The Engraving Task Plate is our general-purpose engraving table surface used for all projects that do not include vector cutting. At a solid 1" (25.4 mm) thick, the engraving task plate provides the most even, flat engraving surface possible so you will have the same engraving quality no matter where you are engraving in your system, from the top-left corner to bottom-right corner. The Engraving Task Plate is easily removable for cleaning when needed by flipping the rulers up and pulling out the table.



SECTION 9: SYSTEM FEATURES

Vector Cutting Table

Vector Cutting Table

The Vector Cutting Table is used when you are cutting all the way through a material, so the laser beam is penetrating beyond the material being cut. The Vector Cutting Table allows the laser beam to continue through the gridded area, reducing backside burning by lifting the material off the table and supporting it on an aluminum honeycomb grid.

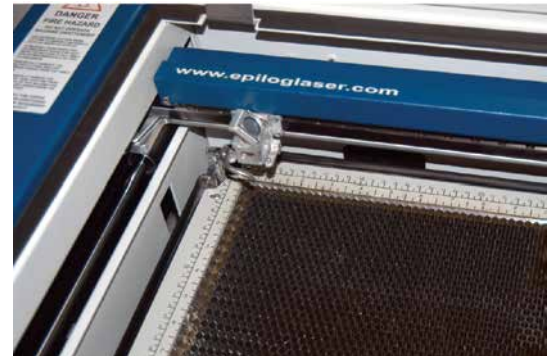

There is a leveling bar located below the vector cutting table that should always be in place to have the most level cutting table possible. To access the bar lift the rulers and remove the gridded table.



Changing the Table

To remove the Vector Cutting Table or Task Plate, lower the table approximately one inch (25.4 mm). Push back on the black backstops on the four sides of the table to flip them up.

Grasp the Vector Cutting Table or Task Plate in the middle and lift it out of the machine. There are slots and finger grips that make removal and installation easy. After installing the other table, flip the table guides down to restore the rulers to their original position.

You can store the racks either near the machine or in the storage racks of the Helix and in the optional Mini Stand.

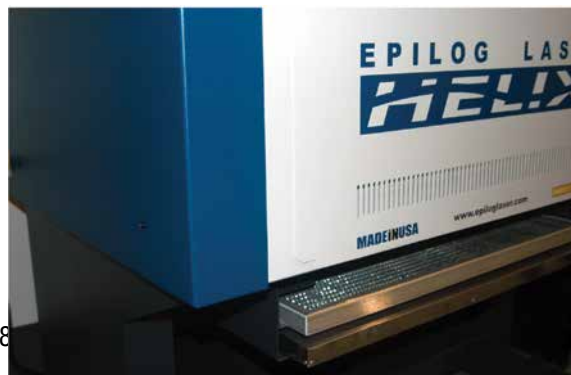

Vacuum Hold-Down Table

The holes in the task plate provide vacuum hold-down capability that keeps thin materials flat while engraving. The exhaust system is designed so that it evacuates from both the top and the bottom of the task plate when the task plate is at its highest position. The exhaust pulls air through the holes and forms enough of a vacuum that it will flatten slightly warped paper, wood, aluminum sheet stock and other materials. As long as the exhaust is operating and the task plate is no more than an inch (25.4 mm) below its highest point, the vacuum table will work.



If you have a piece of sheet stock that does not flatten out because it is not covering enough of the vacuum holes, you can use any material (including paper) to cover some of the exposed holes. Simply blocking most of the vacuum holes will be enough to flatten most sheet stock as long as it is not too severely warped, bent or too rigid. Magnets can be used to hold oddly shaped items in place if needed.

Integrated Crumb Tray

The Integrated Crumb Tray is located under the Task Plate/Vector Cutting Table and collects small debris that falls through the Vector Cutting Table. Open the front access door and flip out the two release tabs to slide the crumb tray out of the front of the machine.



SECTION 10: OPTIONAL FEATURES

Pin Table

Pin Table

The Pin Table option offers an easy way for users to keep all back reflections of the laser beam from marking the sides or back of the material being cut. The Pin Table lifts the cutting material completely off the table and provides a means to eliminate the tick marks that can be created when the laser beam comes into contact with the grid material.

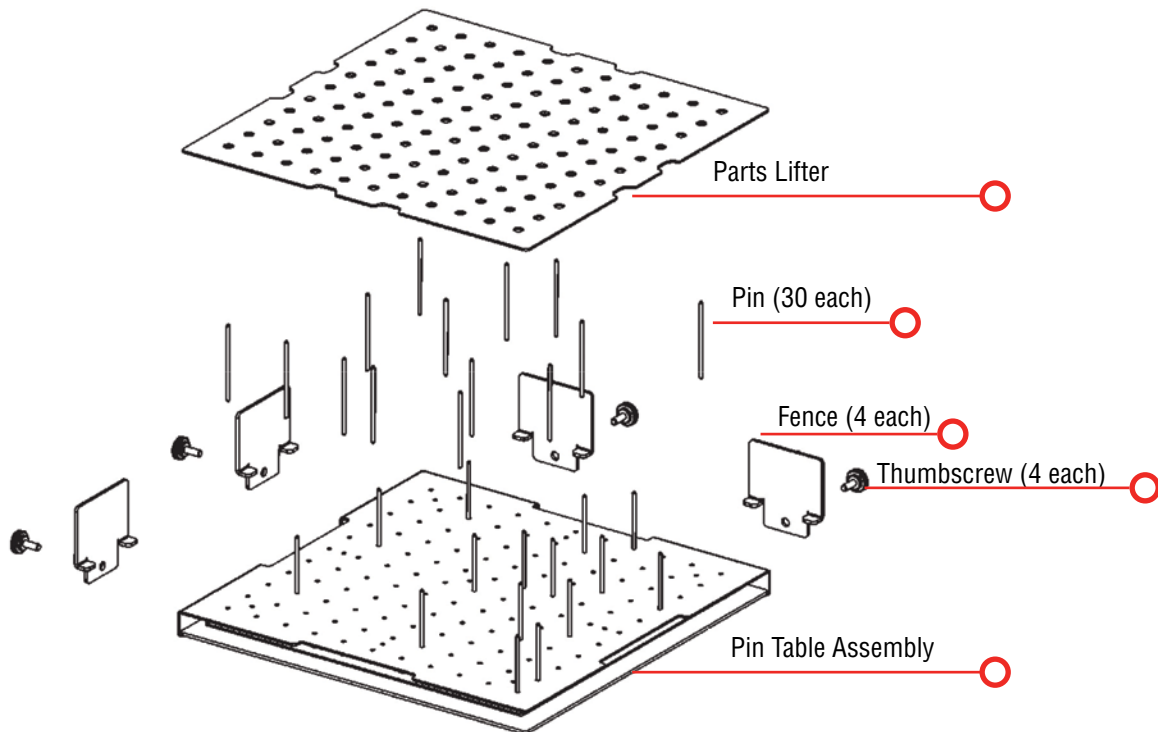

The Pin Table is a 12" x 12" (305 x 305 mm) anodized aluminum table that holds movable support pins that can be placed anywhere on the table's 1" (25.4 mm) grid pattern. The movable support pins allow the user to place the pins anywhere on the grid in such a way that they support the material being cut while avoiding the cutting path of the laser. This method of supporting the material produces cut edges that do not have any marks from laser reflections. By setting up a grid pattern in your graphics package to match the grid pattern of the Pin Table, you can easily ensure that your cutting path will not contact the support pins.

Assembly Instructions

After unpacking the Pin Table, remove the four thumbscrews from the Pin Table assembly.

1. Install the four fences along the two sides using the thumbscrews you just removed.
2. At this point the Pin Table is almost ready to use. The next step involves placing the pins anywhere on the grid so that they support the piece you are going to be cutting, and are out of the laser beam cutting path.

User's Guide

1. Install as many pins as necessary to support your work piece and waste pieces.

SECTION 10: OPTIONAL FEATURES

- The pins are held in place with plastic supports and need to be pressed firmly into place to be fully seated. You may need to use a wooden block to press them in fully.
 - If all pins are not fully seated, the top of the pins will not be level and your work piece will wobble.
 - The grid design allows you to strategically place the pins where they will support your work piece and stay out of the laser's path at the same time.
2. Once the pins are located, place the Pin Table into the upper left corner of your laser system with the fences resting against the left and top edge guides (rulers). If the Pin Table is resting properly against the edge guides you will maintain your 0,0 Home Position in the upper left corner.
 3. Once the Pin Table is in your laser system, place your work piece onto the Pin Table so that the left and top edges of your material rest against the fences.
 4. Send your job to the laser. If the pins are properly located, your job will cut all edges cleanly without the laser contacting any of the pins.
 5. When cutting is complete, use the handy parts lifter to lift your parts from the Pin Table.
 6. When you're ready for your next vector cutting job, you can remove the pins and place them into a new position. The pins are designed to be held snugly in place by the plastic supports. It may be necessary to remove them with the use of pliers.
 7. Additional pins can be purchased from Epilog. Ask for **P/N LF231**.
 8. The Pin Table is designed so that multiple Pin Tables can be set next to each other and maintain the 1" (24.4 mm) grid pattern.

Using the Pin Table:

In CorelDRAW set up a 12" x 12" (305 x 305 mm) page, the same size as the pin table. This can be adjusted if your piece extends beyond the edges of the Pin Table or you are using multiple Pin Tables. Select **View**, and scroll down and click on **Grid** and **Ruler Setup**.

Set the Frequency to 1.0 per inch (both Horizontal and Vertical) and put a check mark in the Show grid box. Click **OK**. Your Corel page now shows a grid pattern that matches the grid of the Pin Table.

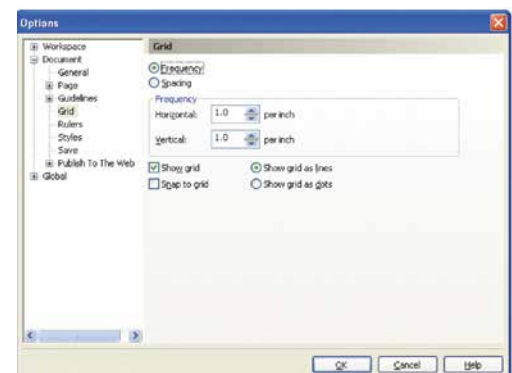
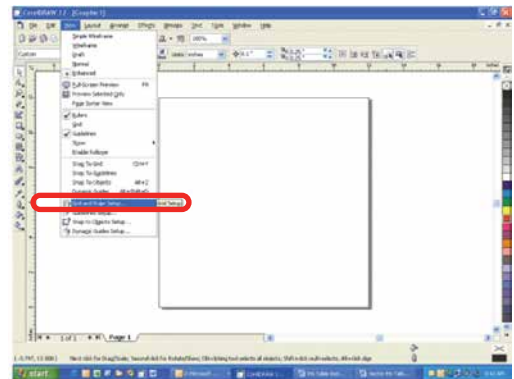

SECTION 10: OPTIONAL FEATURES

Pin Table

Set up your artwork on the grid so that the vector lines do not cross the path of any of the pins. The small black circles within the letter “B” show the location of the pins. Notice that you do not need to place pins in every available space, they just need to be placed where they will support the work piece.

For this piece we have also supported the middle of the “B” to show how to support the waste pieces if you do not want them to fall out after cutting. The circles outside of the “B” are to support the long piece of wood that we are going to use for cutting.

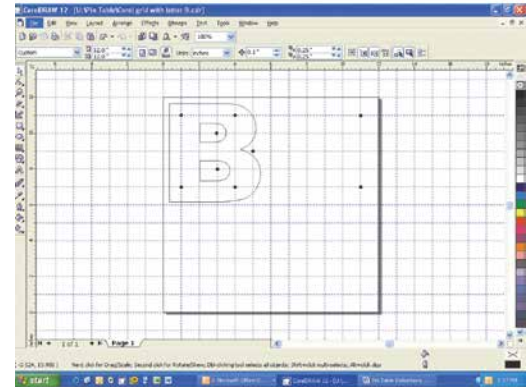

The next photo shows the Pin Table in the machine with the letter “B” cut out and resting on the pins.



Rim-Drive Rotary Attachment

The optional Rim-Drive Rotary Attachment allows you to mark and engrave on cylindrical objects, including glasses, wine bottles, and much more.

Rotary Attachment Installation

1. Lower the engraving table to its lowest point.
2. **Turn off the power to the laser.**



Turn off the power to the engraver. It's important that the laser system is turned off before installing (or removing) the Rotary Attachment!

3. Flip the left, right and top rulers and table guards into their up position.
4. Remove the Task Plate and/or Vector Cutting Table.
5. Remove the Crumb Tray from the bottom of the table. For more information see **“Crumb Tray Cleaning”** on page 73.

Once the Task Plate, Vector Cutting Table and Crumb Tray have been removed you will see three holes in the tray that mate to the three pins on the bottom of the Rotary Attachment. Note that on the Mini 18, one hole is hidden in the cut out on the right side of the table.



Don't see the holes? Have you removed the Crumb Tray yet? See **“Integrated Crumb Tray”** on page 89 to see how to remove the tray.



Before plugging in the Rotary Attachment, make sure the laser is turned off. Plug the attachment into the white connector. It is a keyed connector and will only fit in one direction.

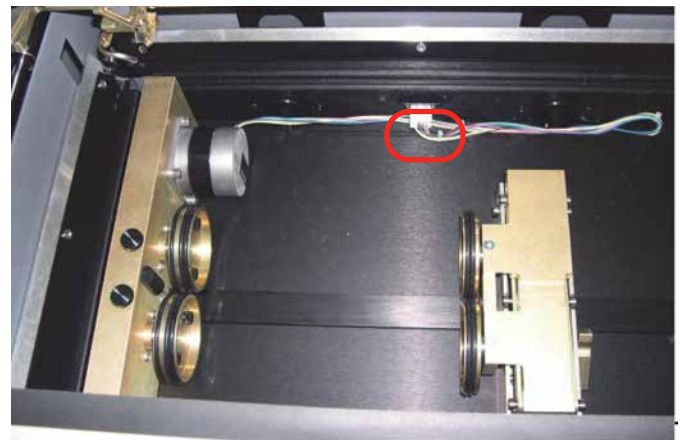

SECTION 10: OPTIONAL FEATURES

Rim-Drive Rotary Attachment

6. Power on the laser. The engraver now knows that the Rotary Attachment is installed and changes its Home Position to a point directly above the center point of the drive wheels on the attachment.

Placing Your Item in the Rotary Attachment

The wheels on the left are the drive wheels which spin the cylinder. The wheels on the right are for support. The right-side wheels are mounted on a scissor jack so they can be raised or lowered to level the top surface of your cylinder with the X-beam. The scissor jack can be moved left and right to accommodate cylinders of different lengths.

Rotate the knob to lift or lower the scissor jack.

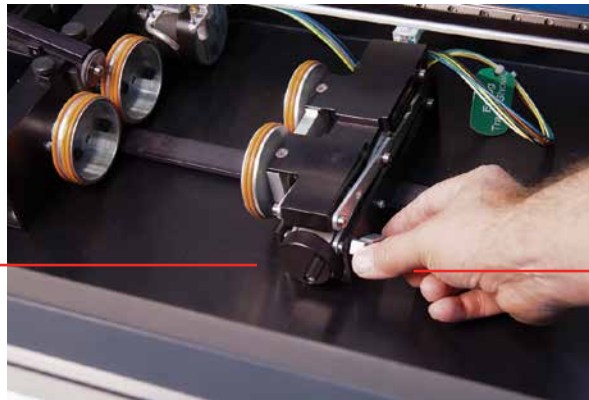

Flip the release lever to move the scissor jack left and right.

In most cases you will want to load your cylinder with the larger diameter on the left (drive wheel side). The scissor jack is used to elevate the right side of your cylinder so that the top surface is horizontal. Load your cylinder onto the Rotary Attachment so that it is just touching the black bumper. Using the clamp to hold the glass in place is optional. Some oddly shaped glasses rotate better if they are clamped to the drive wheels, but most glasses and other cylindrical objects do not require clamping.

This photo shows the clamp holding a glass against the drive wheels. Use the thumbscrews to adjust the clamp in and out.

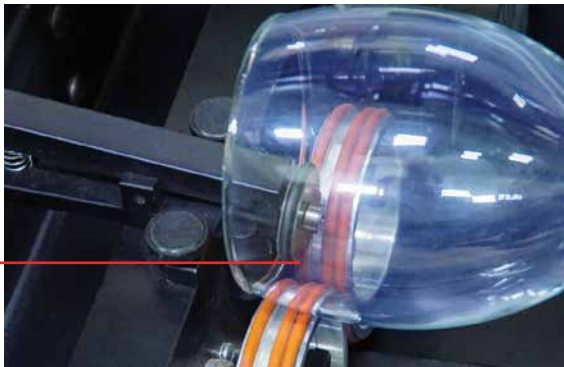

Many glasses, like this one, do not require the use of the clamp. The clamp is used mostly for hard to rotate cylinders or very lightweight objects that need more than just gravity to hold them in place.

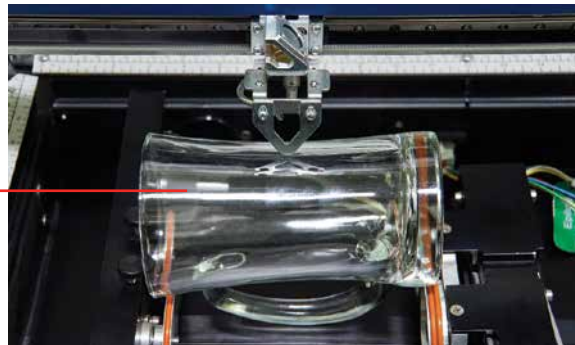

SECTION 10: OPTIONAL FEATURES

Rim-Drive Rotary Attachment

Use the scissor jack to raise the right side of the cylinder so that the engraving surface is horizontal. The photos below show the same flashlight at a severe angle to horizontal. If your cylinder is not horizontal to the X-beam, the laser will lose focus as the carriage head moves across the flashlight. This causes the engraving quality on the right hand side to suffer dramatically.



Incorrect Setup: The flashlight is not horizontal. Raise the right side of the flashlight by turning the jack screw.



Correct Setup: The flashlight is horizontal to the X-Beam



To ensure the area you want to engrave is flat, try placing a small level on the glass to double check the levelness of the area you are going to be engraving.

Setting Focus with the Rotary Attachment

The Auto Focus feature works with the Rotary Attachment. Before using Auto Focus, place the cylinder on the attachment and level the area you are going to engrave. With the item loaded, lower the table until the top surface is below the Auto Focus plunger, then use Auto Focus in the print driver. See **“Auto Focus”** on page 46.

To manually focus your item, place your cylinder on the Rotary Attachment, place the focus gauge on the lens carriage and press the **Focus key**. Use the **Up and Down Arrows** to move the table to the correct focal distance.

If you want to move the focus gauge to a different area of the cylinder, press the **X/Y Off key**, then the **Go key** to move the laser carriage to the point where you want to focus the laser, then press the **Focus key** and use the **Up and Down Arrows** to bring the table to the correct height. Press the **Reset key** to move the laser back to the Home Position.

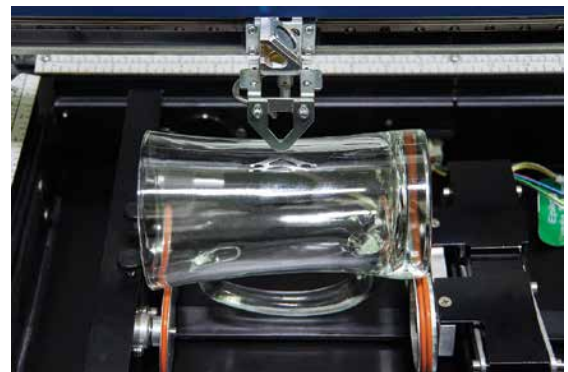

Removing the Drive Wheel

The drive wheels are each two-piece assemblies when fully assembled. Removing the front part of the drive wheel enables users to accommodate a wide variety of mugs with handles. Not all mugs with handles require the front drive wheels to be removed, but for certain types of mugs removing the front wheels adds flexibility to the Rotary Attachment.

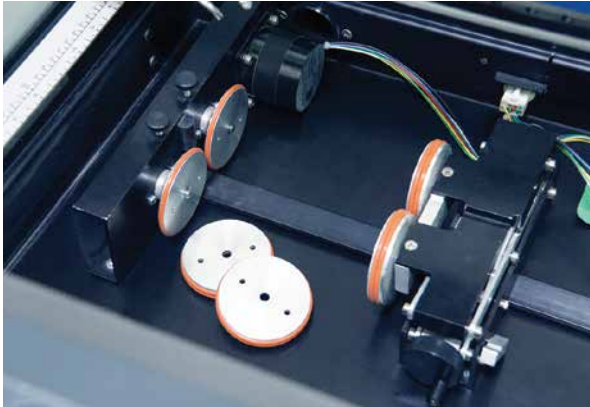

There are two small thumbscrews that attach each front drive wheel to the back drive wheel. Loosen the two small thumbscrews on each wheel to remove the front wheel.



This photo shows a mug with a handle positioned on the Rotary Attachment with the removable portion of the drive wheel shown in the foreground.

Artwork Layout

Because the Rotary Attachment automatically compensates for the diameter of the glass, artwork setup is relatively easy. The most important thing to remember when working with the rotary is that your artwork needs to be rotated 90 degrees to the way it would normally be setup for flat work. There are several visual tools later in this procedure that will help make artwork setup easy.

1. **Set the width of your page (in the X direction) to the length of the glass you are engraving.** For this glass the width of the page is 6" (152 mm).
2. **Set the height of your page (in the Y direction) to the circumference of the glass you are engraving in the area where you will be etching.** Use a flexible tape measurer to find the circumference of the glass at its largest diameter. For this glass, the height of the page is 11" (279 mm).

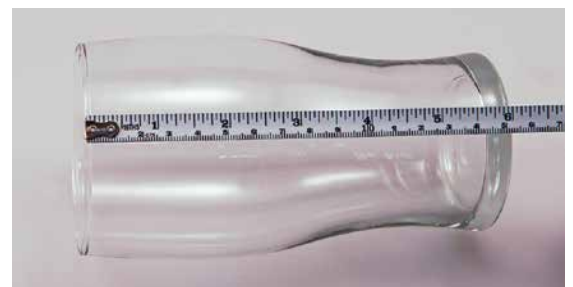

SECTION 10: OPTIONAL FEATURES

3. **Place your artwork close to the top edge of the page.** When the job starts, the first part of the process is for the cylinder to rotate through any white space that is between the top of your page and the top of your artwork. Once it has rotated through the white space it will begin to laser your artwork.

The edge of the black bumper on your Rotary Attachment corresponds to the left edge of your page in CorelDRAW. Set your cylinder on the Rotary Attachment so that it just touches the black bumper. The “top” of a cylinder can be at either end of the Rotary Attachment. It is useful to visualize the orientation of the cylinder when it is being engraved, as is shown in the screen shot on the right.

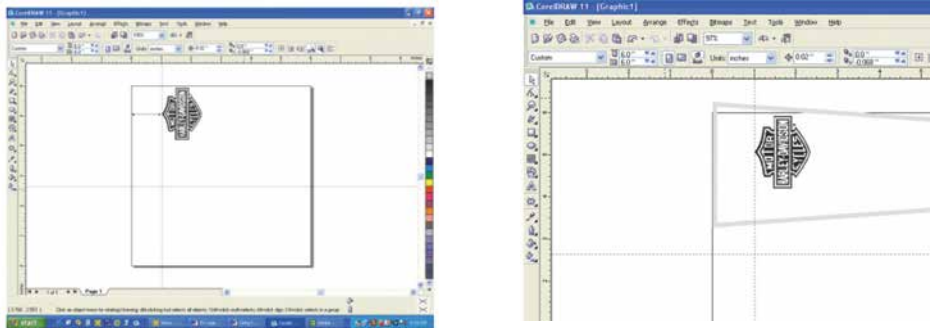

In another example, we've set up this file so the bottom of the logo will engrave 4" (100 mm) up from the bottom of the bottle. The outline of the bottle is just a visual representation of where the logo will appear on the bottle.

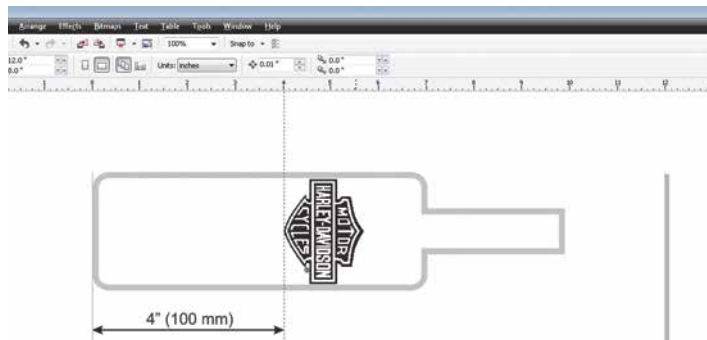

Stretching or Shrinking Your Artwork for Objects with Multiple Circumferences

These instructions show you how to shrink or expand your artwork to accommodate a cylinder where the area being engraved is a different circumference than the circumference at the drive wheels. The Rotary Attachment works with the assumption that the cylinder is the same circumference from end to end and that your artwork doesn't need to be stretched. But some cylinders have a big difference in circumference from the middle to the end that affects how the engraved image looks. It is sometimes necessary to stretch or shrink your artwork so it looks proportional on uniquely-shaped items. The photo to the right shows a glass that fits into this category.

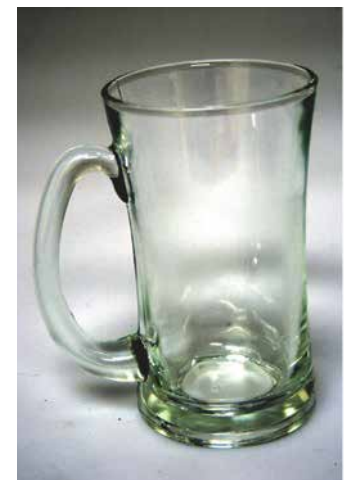

SECTION 10: OPTIONAL FEATURES

This glass has a circumference of 4" (100 mm) at the ends and a circumference of 3.2" (81 mm) in the middle where we want to engrave. Most artwork will look acceptable on this glass without stretching or shrinking, but because the middle of the glass is a smaller diameter than the ends, some artwork will look compressed (more as an oval than a circle), so we'll want to adjust the artwork before engraving.

To determine how much to adjust your artwork, we'll need to do a simple calculation that tells us the percentage of stretch or shrinkage we need to perform. You can use either the diameter or the circumference to make the calculation; just don't mix the two.

Determining whether you use diameter or circumference is a matter of which one is easier to measure. If you want to measure circumference, use a flexible ruler and wrap it around the glass. To calculate circumference, measure the diameter and multiply by Pi (3.1416):

Circumference = Diameter x 3.1416.

For objects with a larger middle section:

Shrink the artwork by dividing the drive wheel side diameter by the middle diameter and multiply by 100 to calculate the percentage of adjustment. For our example the calculation is:

$$\frac{3''}{4.2''} = .715 \times 100 = 71.5\%$$

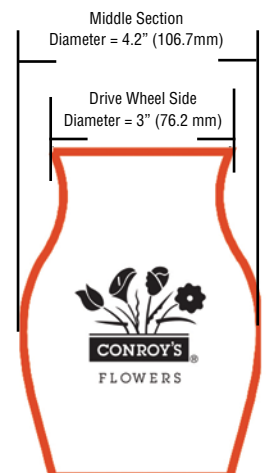

Because our calculation percentage is less than 100, we need to shrink the artwork to 71.5% of its original size. Adjust the size of your artwork in one axis only.

For objects with a smaller middle section:

Expand the artwork by dividing the drive wheel side diameter by the middle diameter and multiply by 100 to calculate the percentage of adjustment. For our example the calculation is:

$$\frac{3.5''}{2.7''} = 1.296 \times 100 = 129.6\%$$

Because our calculation percentage is greater than 100, we need to expand the artwork to 129.6% of its original size. Adjust the size of your artwork in one axis only.

Other considerations:

In these two examples you'll notice that the "middle" varies depending on where you measure. Because of this, you'll never be able to get every piece of artwork perfectly sized. Depending on how much room the artwork takes up, you may want to experiment with the expansion or shrinkage of your artwork to fit your particular glass shape.

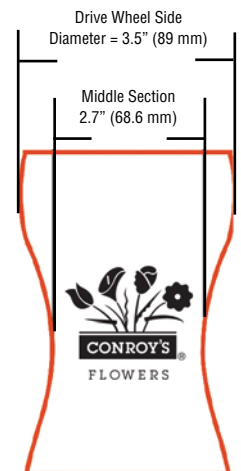

Rotary Removal

1. **Turn off the power** before removing the Rotary Attachment.
2. **Unplug and remove** the Rotary Attachment.
3. **Turn on the machine** and the Home Position will return to the 0,0 point.

Optional Lens Assemblies

There are two optional lens assemblies available for the Epilog Mini and Helix laser systems: a 4.0" (101 mm) lens for cutting inside a recessed area and for cutting thicker materials, and a 1.5" (38 mm) lens for the highest resolution engraving. The 1.5 and 4.0" lens will both work with Auto Focus and Air Assist without any modification or adjustment to either feature.

Remove the two screws that hold the lens assembly to the mounting block.



PhotoLaser Plus

The PhotoLaser Plus software package (PLP) is an optional addition to your Epilog Laser system. Created by CadLink, PLP features an easy method of transforming photographs for your laser engraver, as well as incorporating variable badge making features. This software is not intended to replace your other graphic layout software, such as CorelDRAW or Illustrator; however it is a great complement to your other software.

Epilog only supports PhotoLaser Plus and badge layout functions in the software. The full EngraveLab software is a powerful standalone graphics package. Support for the full EngraveLab is available through CadLink.

Setting Up the PLP Software

Epilog has teamed up with CadLink to bring you a special custom version of PhotoLaser Plus designed for use only with an Epilog Laser system. Primary functions such as printing, Copy, Paste, etc are unavailable unless an Epilog print driver has been established as the default printer within PLP.

1. Go to **Devices and Printers** on your computer and check your print driver's name to be sure the word **Epilog** is included. If it is, you are ready to install the software.
2. If the word **Epilog** is not included in the laser's name, right click on the icon for the laser and select **Printer Properties**.
3. In the **General Tab**, change the name of the printer in the first field to include the word **Epilog**.
4. Insert the CD that came with the software into the disk drive and follow the prompts for a Full Install.

5. After the install is complete, you will need to activate PLP. Open the software and click the OK key on the pop-up screen.

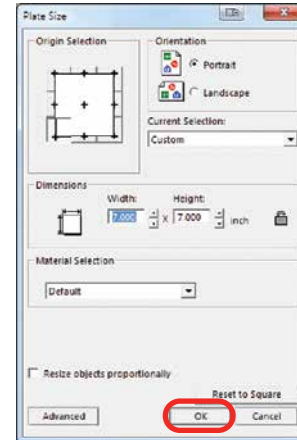

6. Place any graphic on the page. This can be an object, text, or an imported image. Print it by going to **File** then **Print**.

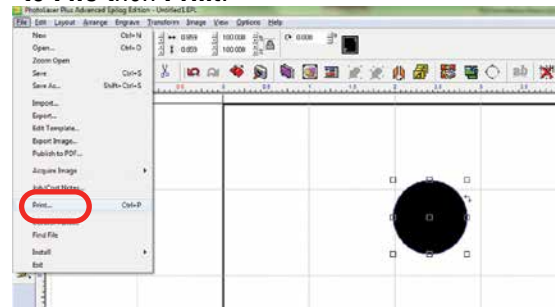

7. **Select your laser in the driver list.** Make sure this has the name Epilog in the driver, or move back to step one. Next close the print window by clicking the red X.

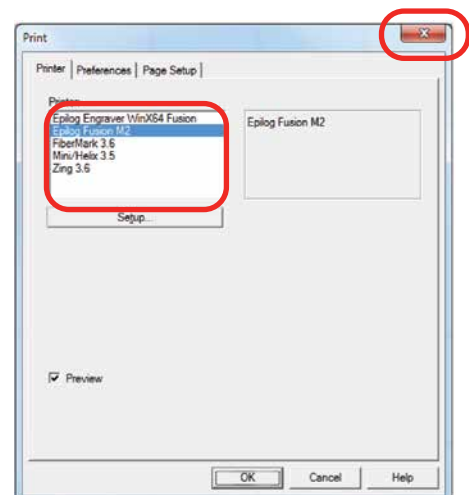

SECTION 10: OPTIONAL FEATURES

8. Close PLP and then reopen it. Now you are ready to use PLP!

PhotoLaser Plus Photograph Transformation

When you first open PLP, your first step is to set your plate size, which is your page size. You can either set this to match the material you are engraving, or the size of the engraving table.

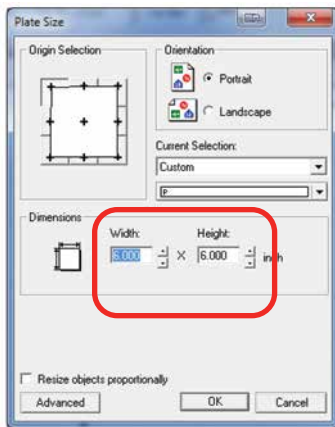

1. Import the photo to be transformed. Select File then Import.

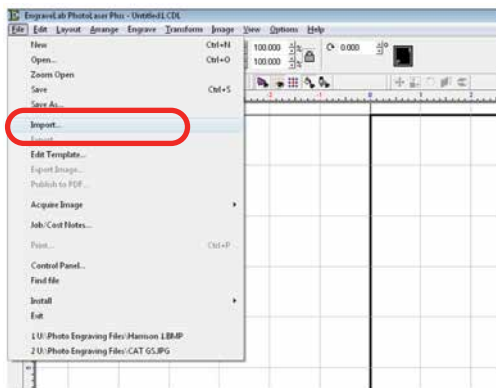

2. If the file looks bit-mapped after the import, select **View** then **Show Reduced Bitmaps** to see the higher resolution version of the image.

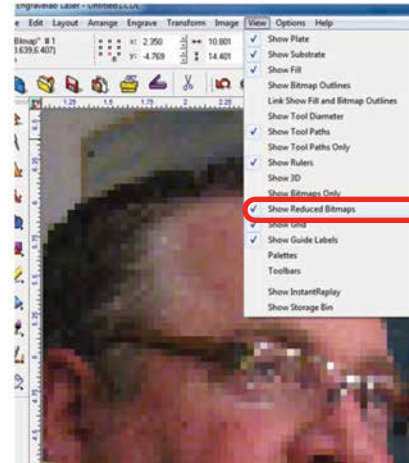

3. **Crop the Photo:** If you do not want to engrave the entire photo, double click on the photo to open the bitmap tools at the top of the page. Select the Rectangle or Ellipse tool to frame the area you want to crop. With the proper area framed, press the Crop key to finalize the crop.

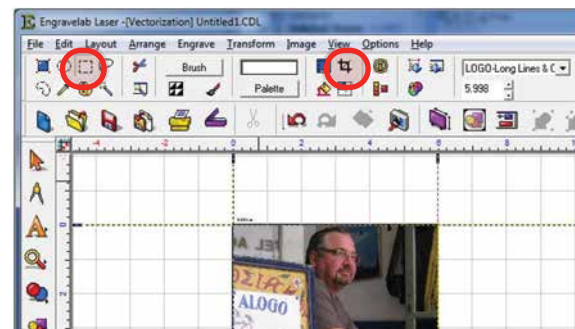

4. **Resize the Photo:** You must now resize the photo to the size you want to engrave. With the photo selected, type in the X and Y dimensions of the photo.

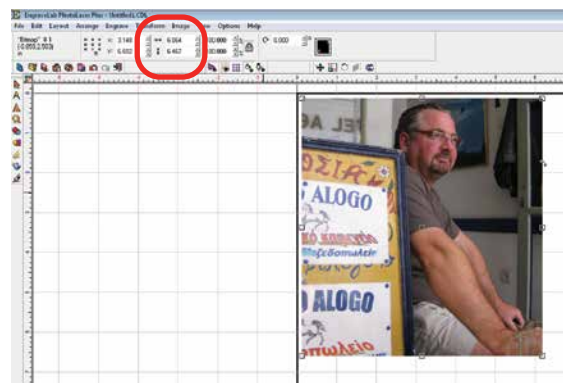

SECTION 10: OPTIONAL FEATURES

5. **Set the Resolution:** This number must match the resolution at which you will be engraving the photo. Select **Image** then **Image Size** from the menu. Type in the resolution and select **Apply**.

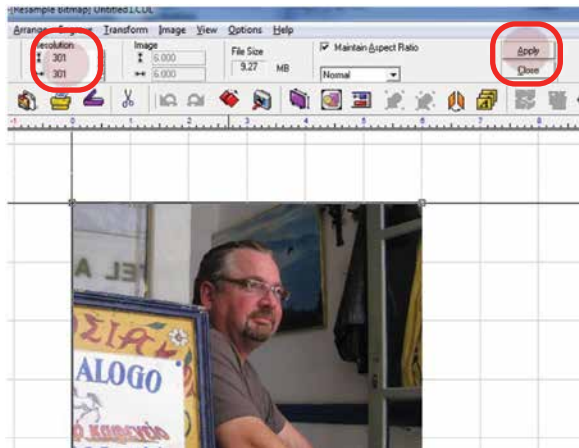

Make sure you have selected **Apply** or the new resolution will not be saved with the image.

6. **Transform the Photo:** With the photo resized and the resolution set, we are ready to transform the photograph. From the menu select **Transform** then **Photo Laser**. Choose **Interactive** to select the material you want to use. Choosing Automatic will apply the material settings you used on your last project.

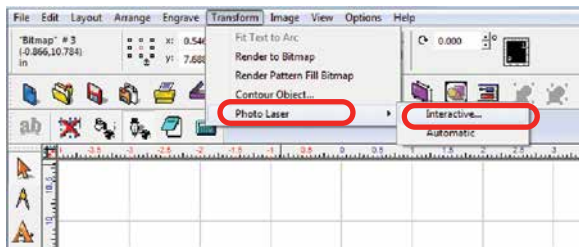

7. Select the yellow folder to open the materials folder.

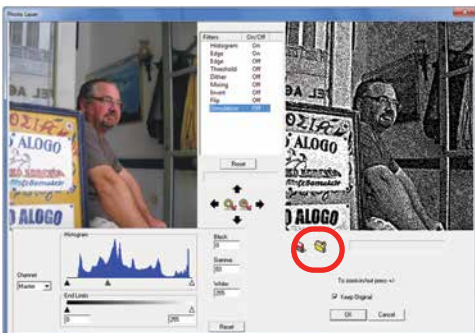

8. Choose the material you are going to engrave. If you don't see the Epilog settings, they can be downloaded from epiloglaser.com/photolaserplus_instructions.htm.

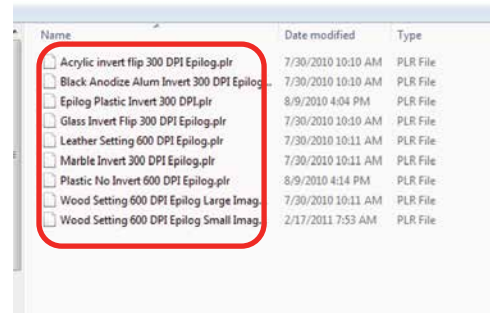

9. If you want to replace the photograph with the new 1-bit photograph, **uncheck Keep Original**, otherwise it will place the transformed image next to your original on the page. Press the **OK** key to finish.

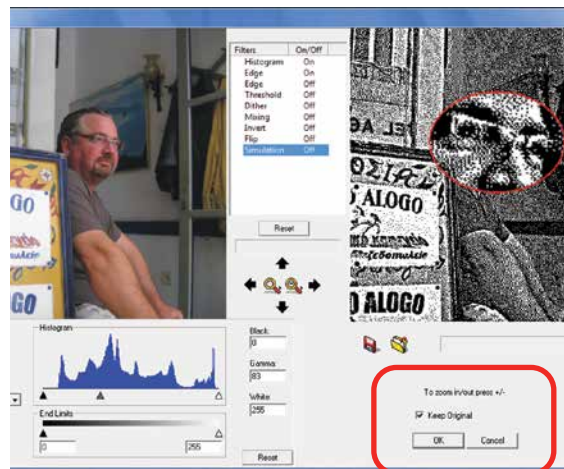

10. You can now print the file to the laser.



Make sure you **print the image at the same resolution as you set in step 6**, or the image will not engrave correctly!

Using CorelDRAW in Conjunction with PLP

This section takes you through the steps to prepare a file in CorelDRAW and use PLP to transform the image. This allows you to use the powerful layout features of Corel or

SECTION 10: OPTIONAL FEATURES

PhotoLaser Plus

other design software along with the photo transformation capabilities of PLP.

1. Start by setting up your file in CorelDRAW. We've designed an 8" x 10" (203 x 254 mm) plaque, added the text and placed a box as a placeholder for the photograph.
2. **Crop the Photograph:** Select the photograph, then select from the menu bar **Effects, PowerClip, and Place Inside Container**. Click the outline of the photo placeholder to place the photo inside the box.

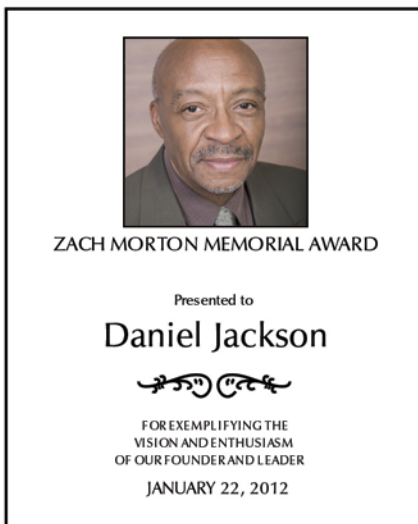

3. To resize or move the photograph in the powerclip box, right click the photo and select **Edit Powerclip**. When you are finished adjusting the image, right click and select **Finish Editing this Level**.

4. **Convert to Bitmap:** With the photo selected click **Bitmaps**, then **Convert to Bitmap**.

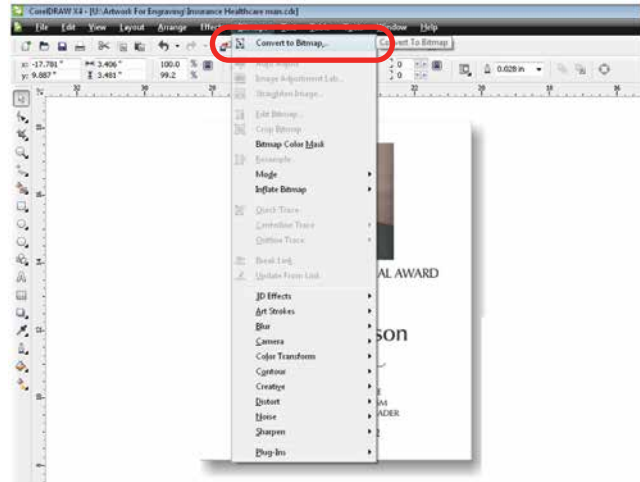

5. Set the resolution to match your engraving resolution. This is usually 300 or 600 DPI. Set the color mode to either RGB, CMYK, or Grayscale (it doesn't matter which one).

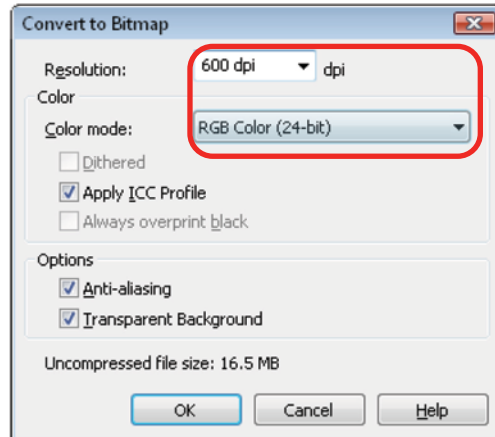

6. Copy the photo in Corel by selecting **Edit**, then **Copy**.
7. Open PLP and paste the image anywhere on the page by selecting **Edit**, then **Paste**.
8. Transform the photo by following steps 6 through 9 in the previous section.
9. After the transformed image is prepared, select **File** then **Export Image**. Export the file as a .bmp. Make note of where you saved the transformed file.

SECTION 10: OPTIONAL FEATURES

- In CoreIDRAW select **File** then **Import** and select your transformed file. Place the photo in the designated space **without resizing the image**.

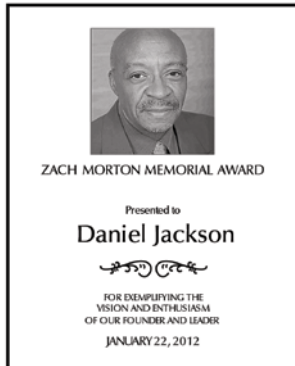

- Print the file from CoreIDRAW as you normally would, using the same resolution that you selected in step 5.

Creating Badges with Variable Names

Another feature of PhotoLaser Plus is its flexible badge layout function. We'll show you how to setup multiple items, such as badges, on one page with different names on each badge.

- Start by opening a new file and setting the plate size to the equivalent of one badge. 3" x 1" (76 x 25 mm) in this example.
- Setup the badge by importing any images.

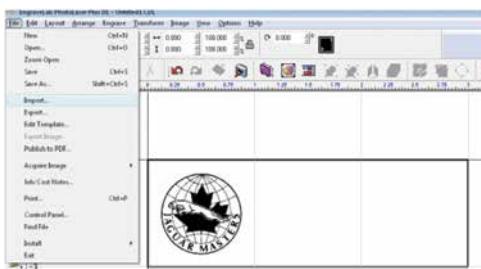

- For the variable name, go to the **Text** tool and select the second option, the **Text Compose** tool (this tool allows you to auto condense long names).

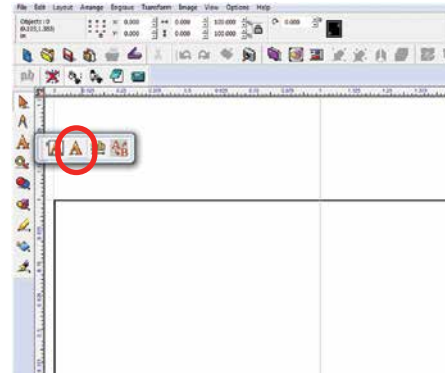

- Click and drag a box within the badge. Size it to approximately accommodate your longest text string. Make sure it fits in the badge area.

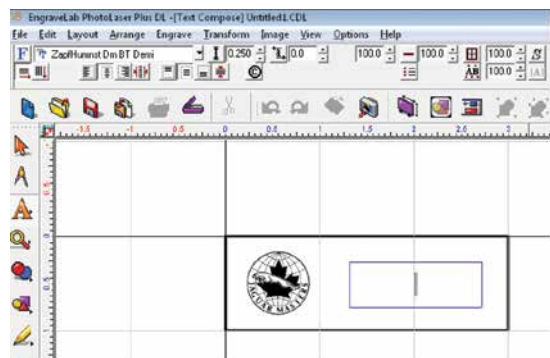

Be sure to click and drag after selecting the tool. Just clicking in the badge will invoke a different use for the tool and you will not be able to auto-condense your names.

- Type your variable in the text box. Here we used the word **Name**. Move it to its proper location on the badge.

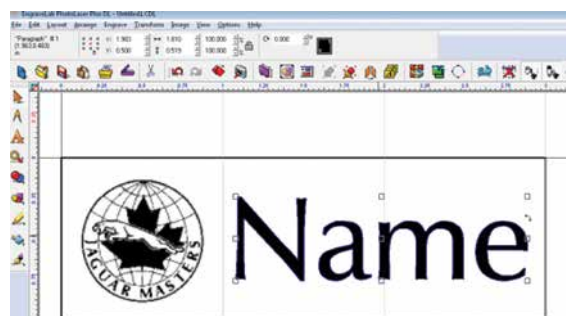

SECTION 10: OPTIONAL FEATURES

PhotoLaser Plus

6. We're now ready to create the badges. First, **select everything on the badge**. If you don't select everything, the unselected objects will not be repeated on the badges.
7. Select the Badges icon in the tool bar.

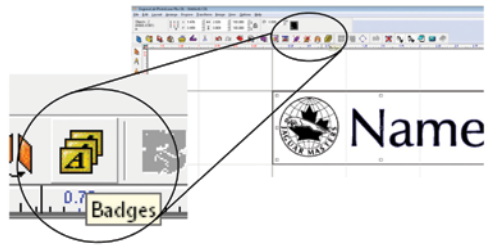

8. Set the Badge Setup parameters as shown below:

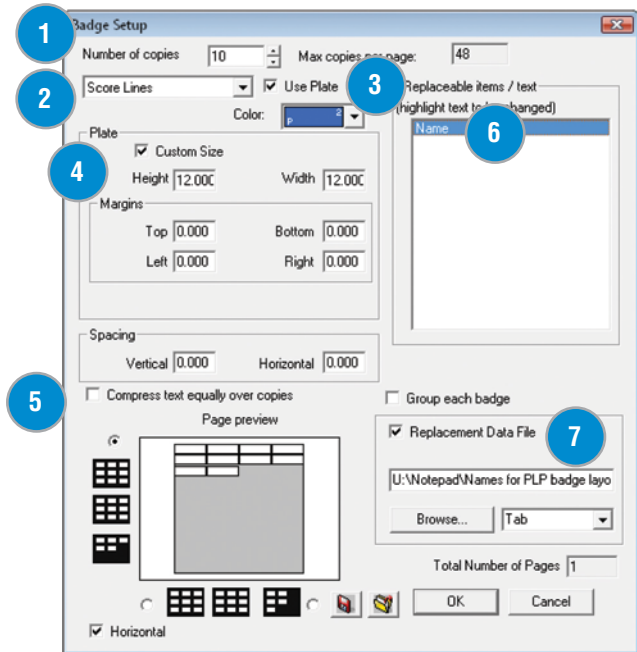

- 1 **Number of Copies:** the number of badges you want to create.
- 2 **Score Lines:** Optional setting that you can use to vector cut badges if you're using material like plastic.
- 3 **Use Plate:** It's important that this be checked so that the graphic corresponds with the actual plate size you're using.
- 4 **Custom Size:** The custom plate size corresponds to the size of your material you're using to engrave the badges. We're going to laser a 12" x 12" (304 x 304 mm) piece of plastic, so we've set this parameter to 12" x 12" (304 x 304 mm).
- 5 **Compress text equally over copies:** You do not need to check this box. Long names will automatically be compressed.
- 6 **Replaceable Items/text:** Select the variable text you typed in earlier.
- 7 **Replacement Data File:** If this box is checked you can browse for a data file that has the names already entered, such as a tab delimited text file. If you do not check this box, a box will open allowing you to type in the data.

9. After clicking OK, the text substitution box will open allowing you to enter or adjust the names for your badges.

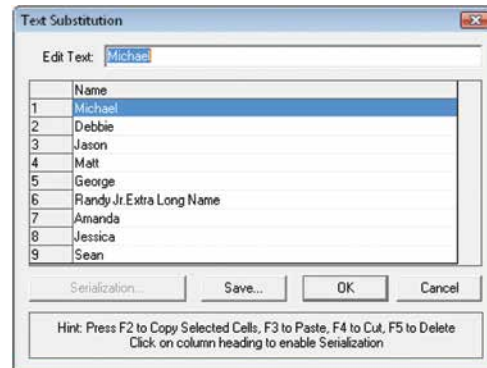

10. After clicking OK, you will be taken back to your drawing page and badges will be properly laid out and populated. You can see that we have ten badges. One was left blank intentionally because we had ten badges and only nine names. You're ready to print your badges to the laser!

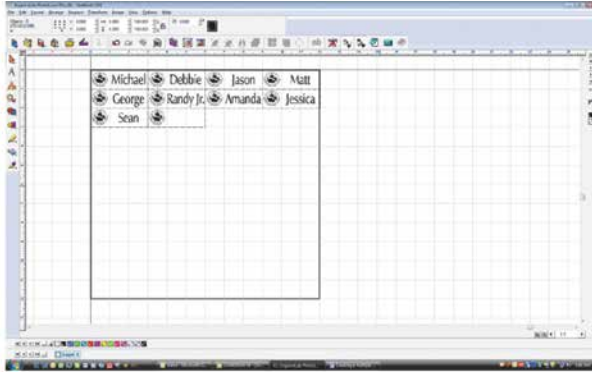

Troubleshooting Badge Layout

Problem: The logo doesn't appear on the badges.

Solution: In step 6, you didn't select everything on the badges before clicking the Badge tool.

Problem: The word **Name** is repeated on all of the badges.

Solution: In the badge setup parameters you didn't highlight Name as the field to replace.

SECTION 11: UPGRADING THE OPERATIONAL FIRMWARE

How to Upgrade Your Firmware

How to Upgrade Your Firmware

Your laser system is capable of having its operational firmware upgraded. The firmware is the command software in your laser system that controls how your laser system operates. A firmware upgrade reprograms your laser system to take advantage of new capabilities or enhancements to the system. To accomplish the reprogramming, you just print a special file to your laser system. The process is explained below.

Upgrading your laser is a two-step process:

1. Download the new firmware to your computer and unzip it.
2. Transfer the new firmware from your computer to your laser.

Installing New Firmware onto Your Computer

Start by checking your current firmware version by powering on the laser. The current version is displayed on the LCD panel, and will read Version 1_0_X_X.

Downloading: From the Epilog web site download the new firmware under **Support + Service > Driver and Firmware Downloads** and save the zip file.



You can also join our Driver Notification mailing list on the download page to be automatically notified when new versions of firmware or the driver become available.

When you download the firmware it comes as a compressed file in the following format: 1.0.X.X.zip. The X's designate the actual version of the firmware. Once downloaded, unzip the file by double-clicking the file. It will open your unzip program.



Find the Unzip To or Extract To selection, and unzip the file to your computer. You will need to pay attention to the folder it is extracted to:



Important! Keep track of the folder where you saved the extracted .hex file. You will need to access this file again in the next step.

Transferring New Firmware from Your Computer to Your Laser

Create a simple drawing in your graphics package. For this example, we've typed in the text **Firmware Upgrade**.

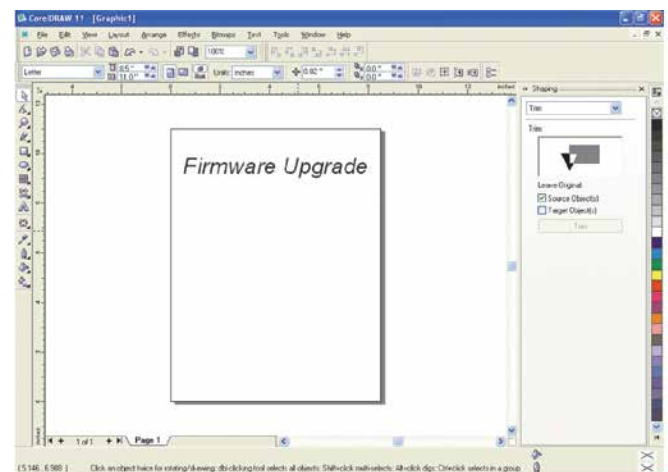

SECTION 11: UPGRADING THE OPERATIONAL FIRMWARE

How to Upgrade Your Firmware

The next step is to **Print**, select your laser in the printer drop-down box and click **Preferences (or Properties)**.

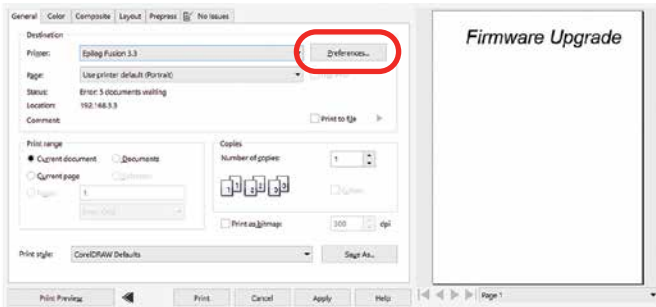

Go to the **Advanced** tab, check the **Update Firmware** box and then click on the **Load** key.



Go to the folder that contains the extracted file, select the **.hex** file and click on **Open**:

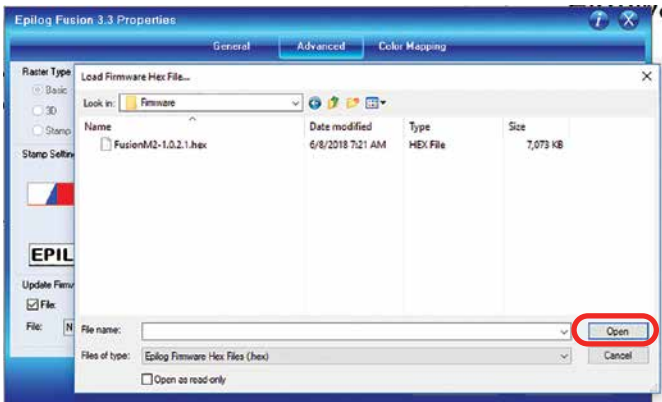

The **.hex** will show in the Update Firmware File box. Click **OK**.

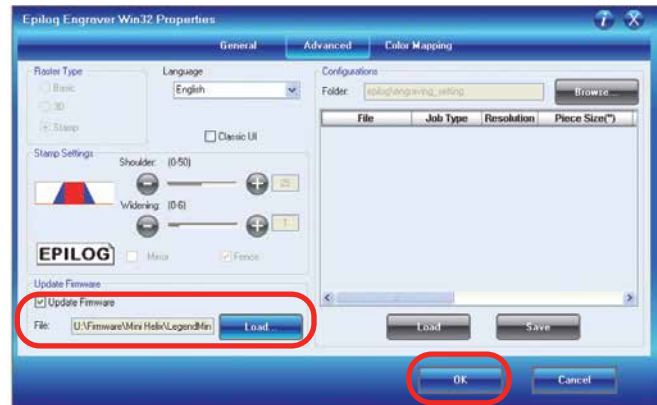

Click **Print**.

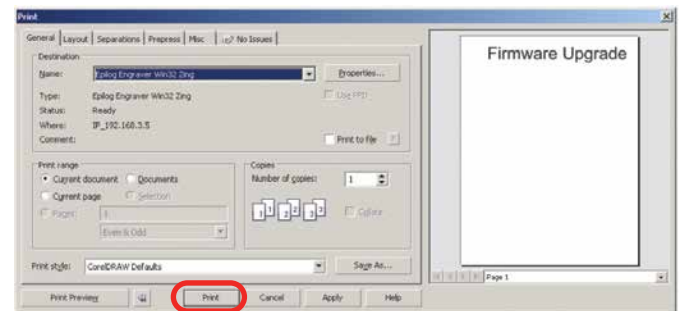

At this point, the **.hex** file will begin transferring to your laser. The laser knows that it is being upgraded and the graphic that you created will not print, nor will it show up as a Job. Instead, the cursor keys will light up. When the upgrade is complete, the display will read **Reboot!**



The programming process takes a few minutes to complete. **Do not disturb the laser during the upgrade process!**

After you have rebooted your laser, the process is complete and you will see the new version number of firmware on your LCD as the laser powers up.

Depending on the type of upgrade you may be requested to reboot more than once. Close your design page and you are ready for your next job!

SECTION 12: PRINTING FROM AUTOCAD

How to Print from AutoCAD to the Laser

How to Print from AutoCAD to the Laser

AutoCAD is a very powerful software tool that is often used in conjunction with the laser for cutting applications. Like any tool, understanding how it works and its limitations are helpful in getting the most out of it. Below are general instructions for printing from AutoCAD. AutoCAD versions 14 to the present are mostly compatible with Epilog systems. Each version of AutoCAD uses slightly different printing conventions that may or may not affect the way you print from AutoCAD and each different version may produce different output from the laser.

Printing/Plotting

Sending jobs from AutoCAD is heavily dependent on the print settings in the AutoCAD Print/Plot window. Since there are so many different settings that AutoCAD requires, it is important that you double-check all of the settings that are critical to success. Previewing your image before sending it to the laser is very helpful in preventing print problems.

AutoCAD is capable of producing extremely complicated drawings with many layers, colors, etc. Since there is no limit to the level of complexity that an AutoCAD drawing can achieve, users should keep in mind that the laser is a 2D cutting machine that usually cuts a single piece of material in any given job. While your laser system is capable of handling complex drawings, users may find that eliminating extraneous detail before “Printing/Plotting” may make their laser equipment more productive.

Color Mapping

Creating objects of different colors in AutoCAD allows the user to take advantage of the Vector Color Mapping capabilities of the Epilog Dashboard print driver. Color mapping assigns different Speed and Power settings to

an object based on its color allowing you to both cut and mark in a single setup. For a detailed description of how Color Mapping works, refer to “Color Mapping” on page 78.

Model Space, Paper Space, and Precise Location

AutoCAD was designed to print to paper plotters and some of the assumptions (especially Scaling and Margins) that AutoCAD makes when printing can cause frustration for laser users that are used to being able to send a job to the laser and have its precise location be very predictable. Printing from either Paper Space or Model Space will work. Be aware that the scaling and margin assumptions made by AutoCAD can affect both the size and location of the work.

Helpful Hints

When printing from AutoCAD **you need to set up your AutoCAD page so that it is square**. This prevents the objects from rotating 90 degrees when you print them. The page in the example below is set to 24” x 24” (610 x 610 mm).

Place all of your objects in the upper portion of the AutoCAD page (see illustration below). If you are printing to a bed size of 24” x 12” (610 x 305 mm) and you have a 24” x 24” (610 x 610) page, the objects in the lower 12” (305 mm) will not be processed.

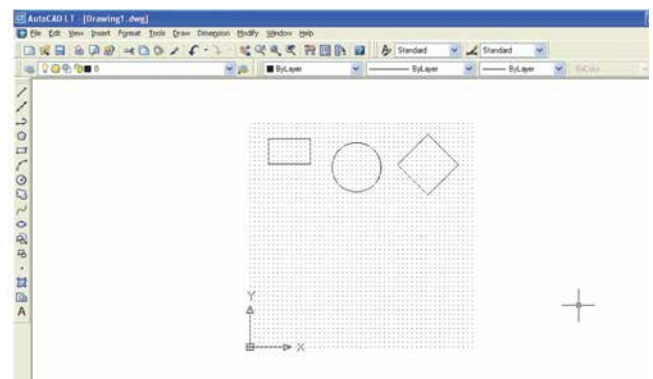

SECTION 12: PRINTING FROM AUTOCAD

How to Print from AutoCAD to the Laser



Set the Piece Size to match your AutoCAD page size. Setting your AutoCAD page and the Dashboard print driver settings to a square configuration (36" x 36", for instance) is necessary to overcome AutoCAD's tendency to rotate your artwork 90 degrees.

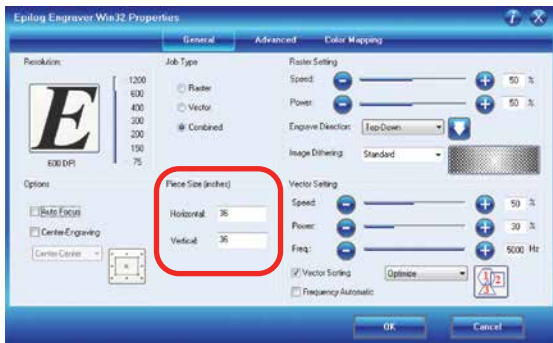

In the AutoCAD print window, set the pen colors that you are using to .001" (.0254 mm).

The AutoCAD default for all pens is .010 and a line weight this large disables vector cutting. If the line weight is not changed to .001 inch, vector cutting will not be possible.

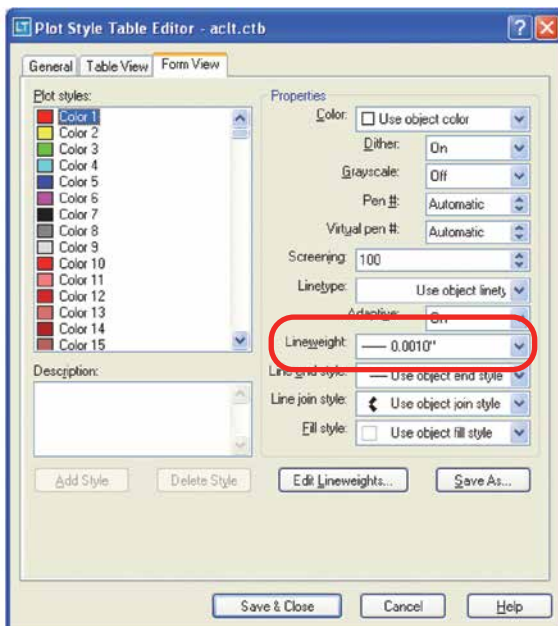

When the laser receives a job where the line weights are too large, the laser system will just beep when you attempt to run the job.

Other useful settings in the AutoCAD print window are:

- Set the page orientation to Portrait.
- Set Plot area to Limits.
- Scale set to 1:1.
- Pen Sizes .001 inch (0.0254 mm).

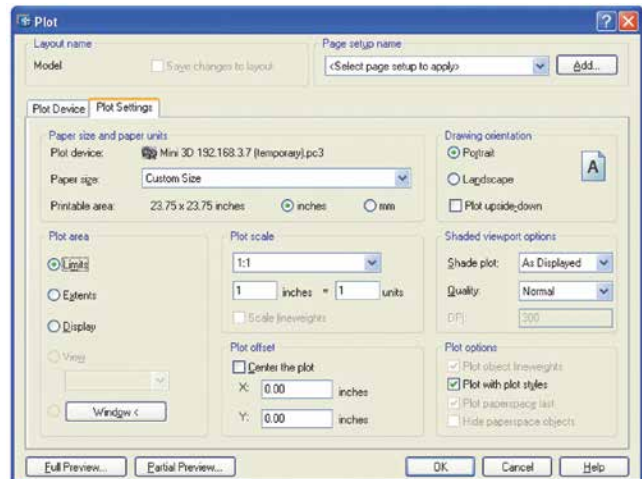

SECTION 13: MATERIAL ENGRAVING TECHNIQUES

Laser Materials/Techniques

Your Epilog Laser system is very versatile. It can mark and cut many different materials. The following section contains information regarding some of the materials the laser will mark and cut. Check the Epilog website (www.epiloglaser.com) periodically for new laser applications, tips and techniques to use with your laser. For specific information regarding materials not mentioned below, please contact your local Epilog representative.

3D Engraving

Earlier in the manual we discussed dot patterns and how those patterns are used to create raster images. 3D mode looks at the dots and the dot patterns in a very different way than basic raster engraving mode, especially when using grayscale images.

In 3D mode, instead of looking at the dots and determining where to fire the laser based on the dot spacing, we look at the dots and determine how much laser power (wattage) to apply to each dot. In basic raster engraving mode, every dot is fired at the same laser output. In 3D mode we have the ability to adjust the laser output for every dot.

An additional aspect of 3D mode is that, unlike basic mode, the laser fires continuously between most dots – even if it is engraving from a 10% fill pattern to a 30% fill pattern. This is by design so there is a gradual change in the depth of engraving when the artwork transitions from one shade of gray to another. The only time that this is not true is when the artwork changes from 100% black to 100% white (or visa versa). Because we adjust the way the laser fires in 3D mode we also have to adjust the artwork that is used to create good 3D images, and this is where 3D engraving can get difficult.

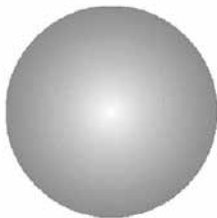

Since we're going to vary the laser power output for every dot, we want artwork that will produce more than one level of gray. We want artwork that gradually blends from one shade of gray to another. You need an object that looks something like this circle to create a 3D image.

Engraving this circle in 3D mode will create a dome with center being the high point (because it's a light shade of gray) and the outside edge being deep (because it's a darker shade of gray).

This explanation describes the most basic functions of 3D engraving and some of the theory behind



In this sample, the black background would be engraved away. Using this technique, the leaf stands up away from the background, with the edges of the leaf being the highest points and the stems being engraved the deepest.



This image would engrave deepest around the edges of the leaf and less deep in the body.

SECTION 13: MATERIAL ENGRAVING TECHNIQUES

it. What it doesn't describe is the difficulty that most users will have in creating acceptable 3D artwork. Creating a 3D image that will look good after engraving can be very difficult to achieve because most software packages do not provide the necessary tools to take complex objects and blend them in more than one direction from dark to light (or visa versa). There are some 3D graphics software packages available that will create 3D images, but they generally cost between \$3,500 and \$10,000 USD. Ask your Epilog representative if you would like more information on these software packages.

Acrylic



Fire Warning: Your laser system uses a high-intensity beam of light that can generate extremely high temperatures when it comes into contact with the material being engraved, marked or cut. Some materials are extremely flammable and can easily ignite and burst into open flame setting the machine afire. This open flame is very dangerous and has the potential to destroy not only the machine, but the building in which it is housed.

Experience shows that vector cutting with the laser has the most potential to create an open flame. Many materials are susceptible to igniting, but acrylic -in all its different forms - has been shown to be especially flammable when cut with the laser.

For more information on fire hazards associated with lasers, please **read the full “Fire Warning” on page 1 of the manual.**

Choosing the Right Type of Acrylic

There are two types of acrylics and each is suitable for different applications. **Cast acrylic** sheets and objects are made from a liquid acrylic that is poured into molds that can be set into various shapes and sizes. This is the type of acrylic used for the awards you see on the market. Cast acrylic is ideal for engraving because it turns a frosty white color when engraved. While it can be cut with a laser, it will not give you flame-polished edges.

The second type of acrylic that you will use with your laser is formed into sheets by a machine and is called **extruded acrylic**. It is formed through a higher-volume manufacturing technique, so it is typically less expensive than cast, and it reacts very differently with the laser. Extruded acrylic will cut cleanly and smoothly and will have a flame-polished edge when laser cut. But when it is engraved, instead of a frosted look you will have a clear engraving.

Acrylic Engraving Techniques

- Most acrylic is engraved on the backside to produce a look-through effect from the front surface.
- Remove the protective adhesive paper from the back of the acrylic before engraving. Leave the front protective cover layer on to prevent scratching while handling the acrylic. Since you are engraving the backside of the acrylic, you will need to reverse or mirror your artwork before sending the job to the laser.

SECTION 13: MATERIAL ENGRAVING TECHNIQUES

- Engrave the acrylic at a high speed and low power. A small amount of power is all it takes to mark acrylic and high power levels tend to distort the acrylic when engraving.
- There are a large number of acrylic products that are painted on one side to add color. You can engrave directly through the paint into the acrylic for a very nice presentation effect. Leave the speed the same as if you are engraving clear acrylic, and increase the power about 10% to get completely through the paint. Applying too much power to the paint will melt it and cause distortion.

Acrylic Cutting Techniques

Acrylic is one of the most popular cutting materials available. It comes in a variety of colors and thicknesses. Laser cutting produces very nice edge quality without the need for polishing or secondary clean up.

- Use the Vector Cutting Table or Pin Table to elevate the acrylic before cutting. Air Assist will greatly reduce flaming when cutting acrylic and should always be used for this material. Information on accessing the Vector Cutting Table is included in **“Vector Cutting Table” on page 88.**
- To find the perfect settings for cutting acrylic, you will need to experiment. Test different speed and power settings by cutting a small shape from a scrap piece of acrylic you will not be using.
- Cutting acrylic is usually best achieved with relatively slow speed and high power. This combination allows the laser beam to melt the edges of the acrylic and produce an almost flame-polished edge.
- Acrylics generally require only a single pass to cut, but thicker acrylics may need two passes. Some users find that spritzing the protective adhesive paper with water produces a better edge when laser cut.
- Setting the focus distance at the center of your acrylic sheet will produce better edge quality than focusing on top of the acrylic sheet.



Warning! Never leave your laser unattended when vector cutting any material! Acrylic is very flammable. **Read the full “Fire Warning” on page 1 of the manual.**

Anodized Aluminum

Anodized aluminum is a coated aluminum that comes in a variety of colors and can usually be easily engraved with a CO2 laser.

- Black anodized aluminum is great to work with because it turns white when engraved and provides the best contrast of all of the colors of anodized aluminum.

SECTION 13: MATERIAL ENGRAVING TECHNIQUES

- Some colors of anodized – red for instance – will not turn completely white when laser engraved. Red anodized will produce a light pink color. Performing a second pass can result in some improvement, but usually a slight shadow of color will remain.
- Engrave anodized aluminum at high speeds and low powers for crisp, clean results. Too much power applied to the anodized coating will distort the engraving and tends to over-burn the image.
-  **Warning!** Metals are reflective. Using full power with them can potentially cause damage to the machine.

Brass - Painted

Since the frequency of the CO2 laser is not compatible with bare metals, uncoated brass cannot be laser engraved. For bare-metal marking you will want to use an Epilog FiberMark system. In order to engrave brass with a CO2 laser you need to use brass that has some sort of coating – typically paint. The laser removes the paint and exposes the brass substrate.

There are two basic types of engraveable brass available, but they are not all compatible with the laser.

- By far, the most popular laser brass is actually brass-coated steel. First, a steel substrate is coated with a thin layer of brass. Next, the brass is polished to a reflective finish and a coat of lacquer is applied to the brass – Victory’s LaserBrite™ product has a lacquer finish. Finally, a paint coating is applied on top of the lacquer for the finished product. When laser engraving brass-coated steel, you are removing only the paint and exposing the polished brass coating that is protected by the lacquer. The lacquer prevents the brass from oxidizing and the bright reflective surface will stay bright for years.
- Some manufacturers also sell painted brass that is solid brass, not brass-coated steel. If the brass is polished before the paint is applied you will have a bright, reflective engraved surface. If the brass is not polished, the result will be a dull, tarnished brass that will require a secondary polishing process after laser engraving. This is time consuming and most engravers do not want to spend the time and effort necessary to turn this into an acceptable product.
- **Note:** Always ask before lasering painted brass if you don’t know the substrate! If you are unsure if your piece is brass-coated steel or genuine brass, you can test the material with a magnet. A magnet will readily stick to brass-coated steel, but since solid brass is not magnetic, a magnet will not adhere to solid brass.

Painted Brass Engraving Techniques

- Engrave painted brass with a high speed and low power setting. It takes very little power to remove the paint coating and too much power will melt the paint and distort the image. If your mark on brass is turning out “fat” or has a balloon appearance to it, you are probably using too much power. Reducing the power will bring back the nice sharp images that are normally produced with painted brass.

SECTION 13: MATERIAL ENGRAVING TECHNIQUES

- **Note:** Use caution when trying to engrave brass coated pens. Many pens have a very hard epoxy paint that is completely unacceptable for CO2 laser engraving. You should only use pens that you have experimented with or that are specifically designed for CO2 laser engraving. Be aware that there are many pens that can be laser engraved with a fiber laser but these pens are usually not compatible with the CO2 laser that you are using.
- Some paints are “almost” CO2 laser engraveable. If you engrave through the paint and there is a slight shadow remaining, try to clean the engraved area with alcohol or lacquer thinner. Depending on the paint, there is a good chance that the shadow will disappear and an excellent engraving result achieved.
- Use caution when trying to engrave blue painted brass. Blue paints contain very aggressive pigments that penetrate the metal surface and it can be extremely difficult to remove all of the blue color, but again, try alcohol or lacquer thinner to remove the shadow.

Glass

When a laser strikes glass it fractures the surface but it will not engrave deeply or remove material. The fracturing of the glass surface will produce a frosted appearance but can cause roughness and chipping depending on the type of glass being engraved. While the frosted appearance is desired, the roughness and chipping are not. Below we explain how to eliminate the roughness and produce a very smooth frosted finish.

The composition and quality of glass varies widely and you cannot always predict the effect that you will achieve. It is always best to experiment with an unfamiliar glass source. Generally speaking, flat glass tends to have a very consistent hardness throughout, and the engraved areas do not tend to have lighter and darker areas. Bottles on the other hand, tend to have soft and hard spots that will cause the engraved area to appear lightly frosted in one area and heavily frosted in another. Engraving at medium speed and high power will somewhat compensate for this, as will two or more engraving passes.

While the laser beam itself is very hot, the heat does not build up easily and it should not prevent you from engraving onto full bottles of wine, champagne or other filled glass bottles. Laser engraving filled bottles is a very popular method of creating custom presentations for special occasions. The laser will not damage the liquid inside the bottle, and as long as you are not completely engraving away a large section of bottle you have very little chance of breaking the bottle.

Glass Engraving Techniques

To produce a smooth frosted finish, here are some tips:

- **300 DPI:** Using a lower resolution, around 300 DPI, produces a better result on glass as you separate the dots you are engraving.
- **80% Grayscale:** Change the black in your graphic to 80% black to improve the engraving quality.
- **Jarvis Dithering:** Running with a Jarvis dithering pattern in the driver (you’ll find this under the raster speed and power settings) will also help provide a smoother finish.

SECTION 13: MATERIAL ENGRAVING TECHNIQUES

- **Masking:** Some people find that applying a thin, wet sheet of newspaper or paper towel a little larger than the engraving area also helps with heat dissipation and improves the engraving. Just be sure that there are no wrinkles in the paper after it is applied.
- **Dish Soap:** Using your finger or a paper towel, apply a thin coat of liquid dish soap – any kind will do – over the area to be engraved. This will dissipate the heat when engraving.
- **Polish:** If there are small shards of glass, you can polish the area with a ScotchBrite pad or something similar.

Note: You need to be especially careful when laser engraving leaded crystal. The lead in the crystal expands at a different rate than the crystal does and this can cause cracking and breakage of the crystal. Using a lower power setting can help this problem, but we always recommend having a spare in case of breakage.

Combining Laser Engraving with Sandblasting

Combining the best of both processes, you can use your laser to engrave the artwork then use sandblasting to provide a deep etch into glass. Using the laser to create the artwork mask is an ideal process for one-of-a-kind custom pieces as well as large production runs. This eliminates the photo process usually associated with sandblast mask.

1. Apply an adhesive-backed mask material to the glass that you are going to engrave.
2. Laser completely through the mask and into the glass.
3. Remove the glass from the engraver and sandblast to the desired depth.
4. You now have a sandblasted glass presentation with the detail of laser engraving!

Notary Seals: Delrin

Notary seals can be easily manufactured using 1/16-inch (1.5 mm) thick delrin plastic. A seal consists of two pieces - a male die and a female die, both shown below. The male die consists of white lettering on a black background and the female die is an inverted and mirrored image of the male. Inverting and mirroring are easily accomplished in most graphics software packages. Simply duplicate the male die, invert the black and white colors, and then mirror the image.



Male Artwork



Female Artwork

SECTION 13: MATERIAL ENGRAVING TECHNIQUES

The male image should be produced without the use of outlines around the text or graphics. Add a .007 to .010 inch (0.178 mm to 0.254 mm) outline to the text and graphics of the female die. This outline creates a large enough void between the male and female dies to emboss paper without tearing.

Apply a .001 outline around the seal to define the outside edge of the seal. Use the Combined Mode to first raster engrave the seal and then vector cut out the seal.

Plastic Engraving/Cutting

There are two types of available engraving plastics: rotary plastics and laserable plastics. Rotary plastics are designed for rotary engraving systems that use a mechanical spinning bit to remove material. Therefore, the depth of the top layer or “cap sheet” was designed to make it easy to rotary engrave. Cap sheet thickness was approximately .010 inches (0.254 mm) thick and laser engraving was nearly impossible because by the time you applied enough power to get through the cap sheet the laser melted and deformed the plastic.

Laserable plastics have been developed with a thinner cap sheet that is .002” to .003” (0.051 mm to 0.076 mm) thick, providing much better engraving and cutting characteristics. These plastics are commonly referred to as micro laminates; micro-surfaced, or simply laser engraveable plastics. These plastics are generally very easy to engrave with a laser since they all have similar characteristics.

Because there is such a broad range of plastics it is necessary to experiment to determine if a particular type of plastic is laser compatible. Different color plastics, even if they are from the same manufacturer, will have unique speed and power settings. Use the guidelines in this manual as a starting point when determining the correct speed and power settings. If you do not get acceptable initial results with the recommended speed and power settings, start experimenting by first changing only the power setting. If adjusting the power setting does not work, start over and adjust only the speed setting. Once you have acceptable results, record those settings for that particular plastic so that you do not have to repeat the experimentation process.

Plastic Engraving Techniques

- Always remove the clear protective cover layer before engraving.
- Once you have the correct speed and power settings you can improve your engraving results even more by taking the focus lens out of focus (lower the table) by about 1/16 (1.5 mm) of an inch. This technique enlarges the focus beam a little bit and provides more beam overlap on each pass of the laser. The greater overlap produces a smoother engraved surface on the plastic and eliminates the grooves that you sometimes see when engraving plastic.
- With some plastics it is best to engrave using two passes. The first pass cuts through the cap layer and the second pass cleans away the residue that some plastics leave behind.

SECTION 13: MATERIAL ENGRAVING TECHNIQUES

- Another technique that can be useful is to mask the plastic before engraving with transfer or masking tape. This will prevent a buildup of residue on the plastic surface. Misting the transfer tape with water will reduce heat buildup and melting on sensitive plastics.

Plastic Vector Cutting Techniques

- Use a Vector Cutting Table to elevate the plastic before cutting. Air Assist will greatly reduce flaming when cutting plastic.
- Vectoring plastics is similar to vectoring other materials. First, experiment to determine if the plastic can be cut with the laser. Plastics that are up to 1/16 inch thick can usually be cut in a single pass. Thicker plastics may need two passes.
- As with engraving, it is sometimes necessary to mask and dampen the plastic before cutting. Even masking and wetting both front and backsides of the plastic is desirable on sensitive plastics that have very low melting points.



WARNING! Never leave your laser unattended when vector cutting plastics! Plastic can be very flammable. **Read the full “Fire Warning” on page 1 of the manual.**



WARNING! Do not engrave PVC (Polyvinyl Chloride). PVC will destroy the optics and mechanics of your Epilog system. Cutting or engraving PVC will void your warranty. The only way to find out if there is PVC in your plastic is to check the manufacturer’s Material Safety Data Sheet (MSDS).

Rubber Stamps

The Dashboard includes settings for producing rubber stamps. Unique stamp attributes are controlled from the driver including, Speed and Power settings, Shoulders, Widening, and more.

Creating Your Layout for Stamps

Set up your artwork in Corel so that your computer image looks like the image that you want to stamp. Areas to be stamped (the raised areas on the stamp) should be black, with the area to be removed white. You can either invert (mirror) your graphic in the graphic software you are using or select “Mirror” in the print driver.

The artwork for a stamp file needs to be set up so that the background of the image will be engraved away and the words and letters remain standing. The two ways of setting up a stamp file are determined by the method you use to define the area that is to be engraved away.

SECTION 13: MATERIAL ENGRAVING TECHNIQUES

Fence Method: This technique uses a closed outline to define the area to be engraved away. This image shows the stair-step outline of a Fence enclosing the logo to be stamped. The laser will engrave away only the background area outlined by the Fence, leaving the logo standing.

This method is useful because it allows you to be very precise about how much background you are going to engrave away, saving time and material. The fence must be .001" (.025 mm) thick and can be any closed polygon or ellipse. You can even place several stamps within one fence.

Page Size Method: Some software programs do not recognize closed outlines. For these programs (Illustrator and some third party custom stamp packages) you need to use the page size to define the area that will be engraved away. Set the page size to the size of the stamp. The laser will engrave away the entire background of the page, leaving the logo standing.

Cutting Out the Stamp: If you are using the Fence Method, any line within the area with a line weight of .001" to .007" (.025 - .175 mm) will be vector cut when sent to the laser.

Creating a Perforated Cut: To create a perforated cut around the stamp that will allow the stamp to be pulled away from the rubber, in the print driver set the vector frequency below 100. This keeps the stamp attached to the rubber sheet and makes cleaning easy while allowing the user to easily remove the stamp from the sheet.



SECTION 13: MATERIAL ENGRAVING TECHNIQUES

Examples of stamp layouts using Fence Method:

Example 1: Single stamp (will not be cut out):

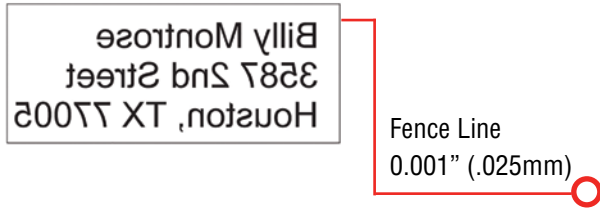

Example 2: Single circular stamp to be cut out:



Example 3: Multiple stamps to be cut:



Example 4: Incorrect! The file contains multiple fence lines. If creating multiple stamps in one file, use one fence around the entire layout.



SECTION 13: MATERIAL ENGRAVING TECHNIQUES

Sending a Stamp File to the Laser

Select Stamp as your Raster Type.

With Stamp mode selected, you can change the shoulder and widening settings (explained below).

The mirror function mirrors everything except the lines to be cut. Only use if not cutting out the stamps with the laser. Mirror your artwork when setting up your file.

Check the Fence box if using the Fence Method.

File	Job Type	Resolution	Piece Size
FusionQualityTest	Vector	600 DPI	12.00 x

Once you have successfully setup your stamp artwork, you are ready to print your design. In the Laser Dashboard go to the Advanced Tab.



If the Stamp Mode is not able to be selected, check on the General Tab that the Job Type selected is either Raster or Combined mode.

Shoulder Settings



The Shoulder setting in the Dashboard adjusts the angle of the shoulders of your characters. A higher shoulder number provides a wider angle and more support for the characters. The following drawing shows a side view of a character with the shoulders set to 6, 25 and 50. Many users feel the default setting of 25 is ideal.

Widening Settings



The Widening setting in the Dashboard adjusts the width of the character at its top. A higher Widening number provides a bolder character. The following drawing shows a side view of the difference in characters when their widening set to 1 or 6. (Note that the Shoulder doesn't change). Many users feel the default setting of 1 is ideal.

SECTION 13: MATERIAL ENGRAVING TECHNIQUES

Stamp Match

The last setting that you may need to make is made from the laser's control panel. The Stamp Match setting is defaulted to 0, which is ideal for most stamp applications. If you notice that there is a little jaggedness at the edges of your stamp letters, adjust the Stamp Match by one or two digits (either up to 1 or 2, or down to -1 or -2 etc). This feature fine tunes the left to right alignment of each raster line and should straighten out any rough edges that may appear. This is a setting that once set should never need to be changed again. To change the Stamp Match setting, refer to the Engraving Machine Calibration / Maintenance section in this manual.

Wood

Solid Wood

Wood is by far the most laser-friendly material available because it can be engraved or cut very easily. When engraved, lighter colored woods like Cherry or Maple produce a very nice contrast where the laser burns away the wood. This high visual contrast is what makes lighter woods so popular when combined with a laser. There are many types of other wood products that are designed for use with the laser and many more that are waiting to be discovered by you.

Every type of wood has its own characteristics. Some wood is denser than other wood, with the denser, harder woods requiring more laser power to cut or engrave. Epilog recommends that when working with wood other than the ones listed in this section that you investigate the engraving and cutting characteristics before committing to use. There are woodworking shops in nearly every large city that will have a wealth of information on nearly all woods. If you have access to the Internet, perform a search on different types of wood and their characteristics to see what you find.

- The most common woods used with the laser are cherry, walnut, maple, alder, and oak. These woods are considered hard woods, and have grains that work well with lasers.
- Grain can vary greatly in density. Cherry, alder, walnut and maple all have fairly little veins of grain in them, while Oak has medium to large veins in it. For example: If a large box was engraved into a piece of cherry and a piece of oak, the box engraved into the cherry would have a very uniform appearance, the area engraved or the background would be smooth with little variation in height. The oak on the other hand would vary greatly in height and have a very non-uniformed appearance.
- Cherry and alder are the most popular woods for engraving. The light, red color of these two woods provides an excellent contrast when engraved.
- **Engraving bare wood:** When engraving bare wood, the smoke and debris produced while engraving can become embedded into the grain of the wood. To reduce this effect, always engrave with the Bottom-Top setting in the driver.
- **Engraving stained wood:** A stained wood is preferable for engraving because excess smoke and debris can be wiped off the surface of the wood after engraving with water.

SECTION 13: MATERIAL ENGRAVING TECHNIQUES

Manufactured Wood Products

When choosing a manufactured wood product for engraving and cutting, we have found MDF to be vastly superior to plywood when working with a CO2 laser. Since plywood is constructed of layers of wood glued together and the grain of the wood chips in the plywood run in different directions, it is difficult to obtain a consistent depth when engraving. Air bubbles within the plywood cause problems because they severely disrupt the laser beam when cutting. Because of the glue, air bubbles and other factors it is virtually impossible to cut cleanly through plywood.

MDF is an engineered wood product that contains wood fibers that have been glued together. Since there are not individual layers of wood glued together, like in the plywood, the engraving and cutting results are much better. You will produce some charring on the edge of MDF when cut, so you may need to sand the edges after cutting.

Wood Engraving Techniques

- To create a quality image on wood, contrast and depth are usually desired. The higher the power level, the higher the contrast and depth will be.
- **Speed and Power Settings:** Wood is a great material to laser engrave because it discolors when engraved and the depth of engraving is greater than most materials. The downside is that it takes a lot of power to deeply engrave wood at high speeds. Most wood can be engraved using full power no matter whether you are using a 30-watt laser or a 120-watt laser. Depending on the wattage of your laser, the best approach is to set the laser power at 100% and adjust the speed to obtain the desired depth.
- **Resolution Settings:** Wood is a very easy material to work with and you can produce very nice detail with as little as 300 DPI engraving. 600 DPI engraving into wood produces fabulous results, especially on photos.
- **Grayscale:** Grayscale graphics look wonderful when engraved into wood. The reason for this is that the wood will react much differently to each level of grayscale, providing amazing contrast. Experiment! Take a piece of clipart and ungroup it and change the colors so that they range from a dark color like red, to a light color like yellow, then engrave it. This will create a shading effect that is almost 3D in its appearance.

Wood Vector Cutting Techniques

Epilog Laser systems are ideal for cutting through solid wood material. The thickness of the wood that you can cut varies with the wattage of the laser and the hardness of the wood, but in general you can cut approximately ¼ inch (6.35 mm) wood with a 30-watt laser and up to ½ inch (12.7 mm) wood with a 120-watt laser.

- When cutting wood of any thickness, Epilog recommends the use of the Vector Cutting Table and Air Assist options. The Vector Cutting Table raises the wood off of the solid metal engraving table and supports the wood on an aluminum grid. The grid greatly reduces backside burning of the wood and also provides ventilation that allows the fumes and smoke to be exhausted to the rear of the engraving cabinet. Information regarding accessing the Vector Cutting Table is located in “**Vector Cutting Table**” on page 88.

SECTION 13: MATERIAL ENGRAVING TECHNIQUES

- Air assist greatly reduces flaming that may occur if too much laser power is applied to the wood piece being cut.
- Depending on the type of wood being vector cut, it is sometimes advantageous to apply a cover of masking or transfer tape to the surface before cutting. The masking tape will reduce residue buildup on the top surface of the wood surrounding the cut line.
- Reduce the frequency settings in the driver to around 20 for a better laser-cut edge. The laser will pulse with less frequency, reducing the charring and burning on the side of the wood.
- If you are cutting through thicker materials, focus the table up so that the new 2" focal distance will be to the center of the wood.



Warning: Wood is a combustible material. Never leave your laser unattended while vector cutting any material. Air assist greatly reduces flaming that may occur if too much laser power is applied to the wood piece being cut. **Read the full “Fire Warning” on page 1 of the manual.**

Wood Cleaning Techniques

When laser engraving or cutting wood, resin in the wood comes to the surface, mixes with the smoke and is deposited as a residue. If the wood has a coating of polyurethane or lacquer, the coating protects the surface of the wood from the resin/smoke damage. You can remove the resin from coated materials with a wet chamois or a sponge with a web cover. Some people like to use 409, Windex or other mild cleaning product, but water works well and is usually the most readily available wetting agent. The chamois that Epilog recommends has a sponge in the middle of it, and is available in the automotive car wash section of many discount stores or many automotive supply shops.

- If the wood is not coated with polyurethane, the resin and smoke will stain the surface and you will need to sand the surface to remove the resin.
- Never use a paper towel to clean the wood surface. The paper towel will shred and it is impossible to get the shredded fibers out of the engraved recesses of the wood. Most wood products that are designed for laser engraving will have a polyurethane coating so that they are very easy to clean.

Wood Color Filling Techniques

Color filling engraved areas of wood adds either greater contrast or a splash of color to your wood presentation. Normally, color filling is not required for lighter colored wood materials such as maple or cherry, but walnut can often benefit from adding a black color fill to provide more contrast. You will need to take some precautions when color filling wood, because if you are not careful, the liquid color fill material will absorb into the grain of the wood on the surface of the plaque where it is not wanted.

The best way to add a black color fill is shown below:

1. Apply a thin coat of Johnson’s Paste Wax to the surface of the wood before you engrave it.

SECTION 13: MATERIAL ENGRAVING TECHNIQUES

2. Engrave through the paste wax into the wood. Do not wipe off excess paste or residue after engraving.
3. Fill the engraved voids with Turtlewax “Color Core” black liquid car polish. The car polish will absorb into the engraved wood grain, but will not absorb into the wood grain that is covered with paste wax.
4. Wrap a paper towel around a block of material that has a flat surface. Rub the flat surfaced paper towel over the surface of the wood to clean off the excess car polish and paste wax. The flat surface prevents the paper towel from getting into the engraved recesses.

SECTION 14: SPECIFICATIONS

Epilog Mini / Helix Laser Technical Specifications

Epilog Mini / Helix Laser Technical Specifications

	Epilog Mini 18	Epilog Mini 24	Epilog Helix
Maximum Engraving Area	18" x 12" (457 x 305 mm)	24" x 12" (610 x 305 mm)	24" x 18" (610 x 457 mm)
Max Material Thickness	4" (102 mm) Remove table for 6" (152 mm) depth and 17.5" x 10" (444 x 254 mm) engraving area.	5.5" (140 mm) Remove table for 8" (203 mm) depth and 23.5" x 11.75" (597 x 298 mm) engraving area.	8.5" (216 mm) Remove table for 11" (279 mm) depth and 23.5" x 17" (597 x 432 mm) engraving area.
Laser Source Wattages	30 or 40 watt, CO2, air-cooled, all-metal tube, 1062 micrometers.	30, 40, 50 or 60 watt, CO2, air-cooled, all-metal tube, 1062 micrometers.	30, 40, 50, 60 or 80 watt, CO2, air-cooled, all-metal tube, 1062 micrometers.
Standard Features	Air Assist, Auto Focus, Red Dot Pointer, Integrated Vector Grid & Vacuum Table, 2" (51 mm) focus lens, relocatable Home Position, permanent job save with 10, 2 MB files, easy-access drop-down door, Super-Silent Cooling Fans.		
Intelligent Memory Buffer	Store multiple files up to 64 MB. Rolling buffer allows files of any size.		
Operating Modes	Optimized raster, vector and combined modes.		
Motion Control System	High-speed, continuous-loop, DC servomotors using linear and rotary encoding technology for precise positioning.		
X-axis Bearings	Ground and polished, stainless steel long-lasting bearings.		
Belts	Advanced B-style double-wide Kevlar belts.		
Resolution	User controlled from 75 to 1200 DPI.		
Speed and Power Control (engraving depth)	Computer controlled speed and power in 1% increments to 100%. Color mapping links speed, power, frequency and raster/vector mode settings to any RGB color.		
Print Interface	10Base-T Ethernet or USB connection. Compatible with Windows XP/Vista/7/8/10.		
Size (W x D x H)	27.8" x 26" x 13.5" (W x D x H) (706 x 660 x 343 mm)	34.5" x 26" x 16" (W x D x H) (876 x 660 x 406 mm)	36.5" x 32" x 39.8" (W x D x H) (927 x 813 x 1011 mm)
Weight	70 lbs (32 kg) 100 lbs (45.5 kg) w/stand	90 lbs (41 kg) 120 lbs (55 kg) w/stand	180 lbs (82 kg)
Electrical Requirements	Auto-switching 110 to 240 volts, 50 or 60 Hz, single phase, 15 amp AC.		
Ventilation Systems	350-400 CFM (595 - 680 m3/hr) external exhaust to the outside or internal filtration unit is required. There is one output port, 4" (102 mm) in diameter.		
Laser System Classification	Class 2 Laser Product - 1 mW CW MAXIMUM 600-700 nm.		

Technical specifications and product configurations subject to change without notice.

Compatibility

Your Epilog Laser has been designed as an “open architecture” product that can be run from almost any Windows based software. Epilog provides both Windows 32-bit and 64-bit print drivers.

Recommended PC

For Optimum Computer Performance

Investing in a new computer is a great way to make sure you’re getting the most out of your new laser equipment. Why? Because today’s software (CorelDraw for instance) requires a lot of computer processing speed and memory to function properly. A good computer won’t make a big difference in how your laser runs, but when compared to a slow computer it will save untold amounts of time and frustration setting up the artwork that you “print” to the laser. Many users do not purchase new computers for use with their new laser because their current computers are perfectly adequate. There’s no magical cut-off that makes a computer too slow. If you’re comfortable with the performance and speed of your current computer, there’s probably no reason to purchase another one. The following recommendations are just advice to consider if a new computer is necessary.

A new computer doesn’t have to be expensive to work great. Even many of today’s lower cost computers work great for laser applications. Read these recommendations and consider spending just a few dollars more for those components that will save you time and frustration.

Operating System

While the laser is compatible with Windows 32-bit or 64-bit XP, 2000, Vista, Windows 7, Windows 8, and Windows 10 operating systems. The Epilog Job Manager will only work with Windows 7, 8 or 10.

RAM – Random Access Memory

4 GB is the minimum that is recommended. RAM is like short-term memory. It’s fast and readily available for the computer to access and makes time consuming tasks go much quicker if you have lots of it. Having more than 4 GB of RAM is nice if you demand a lot from your computer.

Processor Speed

A faster processor will allow you to do more tasks in less time. While it’s not necessary to purchase the fastest processor available, you’ll want adequate speed to operate your graphics program. Processor speeds are always improving, but processor speeds of about 2.0 GHz or faster are a good place to start.

10/100 Network Interface Card (NIC)

All new computers have a 10/100 network connection as standard equipment. As well as allowing multiple computers to be linked together in a network, this technology also allows direct printing from the computer to the laser. Epilog supplies a network Crossover cable with each laser system that allows one computer to print to a single Epilog Laser system.

Hard Drive

This is the permanent memory in your computer. Many users feel that you can never have a large enough hard drive. Luckily, most computer manufacturers put high capacity drives in new computers these days. When in doubt, buy bigger than you think you might need. It's so in-expensive that it's worth the peace of mind to have it available.

Software

Many users use Corel as their graphics software. Many other Windows software applications can also be used, although all software is different and may not be predictable, user friendly or functional. Additionally, the technical support staff at Epilog may be less familiar with software other than Corel and less able to help with questions. Consult with your Epilog distributor on software compatibility issues. Epilog does not guarantee compatibility with any software.

PhotoLaser Plus is a third party software for converting photos to laser compatible format. This is an indispensable option for engraving photos.

Heavy Duty Surge Protector

The need for a surge protector varies greatly throughout the world. If the laser is operated anywhere that the electrical power is subject to spikes, outages, lighting, fluctuations, etc, a surge protector should be used on both the laser and the computer. A surge protector is a very cheap insurance policy against catastrophic electrical damage. A surge protector is designed to be an inexpensive device that absorbs any electrical problems before they can damage the expensive equipment (computer and laser) they are protecting.

About The CO2 Laser Source

Your Epilog CO2 laser system uses the latest in laser technology to provide a powerful tool that is simple and safe to setup and operate. The Epilog Laser can mark, engrave, and cut a variety of non-metallic materials.

The CO2 laser beam itself is invisible and operates at a wavelength of 10.6 microns. The beam is about half the diameter of a #2 pencil. Unfocused, it will just make an ugly burn, leaving lots of charred material behind. The focus lens gives the beam an hourglass shape. At the center point the energy density is concentrated, allowing the very precise and clean material removal that is characteristic of laser engraving. The center of the hourglass is the focal point.

The laser beam path is completely enclosed within the cabinet. Please do not disassemble or modify any of the covers or windows on the machine. If at any time you notice that the laser operates with a door or window open, please contact Epilog technical support immediately.

The laser has two basic operating methods. For cutting (vector), the laser is driven along a path and the laser is left on all the time. The path could be the outline of a letter or a geometric shape like a circle. The laser will cut entirely through the material, separating the part from the background. For marking (engraving), the laser is swept across the work from left to right, and the laser is turned on and off at the correct points to produce the first line of the image. Then the carriage advances one line and the process is repeated, eventually assembling a full image.

SECTION 14: SPECIFICATIONS

Federal Communications Commission (FCC) Notice

Federal Communications Commission (FCC) Notice



This equipment has been tested and found to comply with the limits for a Class A digital device, pursuant to Part 15 of the FCC rules. These limits are designed to provide reasonable protection against harmful interference when the equipment is operated in a commercial environment. This equipment generates, uses, and can radiate radio frequency energy; and, if not installed and used in accordance with the instruction manual, may cause harmful interference to radio communications. Operation of this equipment in a residential area is likely to cause harmful interference, in which case the user will be required to correct the interference at his/her own expense.

SECTION 15: TECHNICAL SUPPORT

Contacting Technical Support

Contacting Technical Support

The technical support department at Epilog is available to assist with solving problems you may encounter using your Epilog. Please review first the common problems and solutions as noted below, then if you are still in need of assistance you may contact Epilog's technical support department at the number or website listed below. Technical support is available in Golden, Colorado USA during the hours of 6 a.m. and 6 p.m. Mountain Time.



Technical Support Direct Line: 1 (303) 215-9171

Email: tech@epiloglaser.com

Technical Support Online: support.epiloglaser.com

What to do prior to contacting Epilog Technical Support:

1. Have the machine serial number available.
2. Have time to work on machine. Many issues will require troubleshooting.
3. Clean your machine (especially the optics), this will solve many issues.

The machine serial number can be found on the Certification/Identification Label. This engraved plate is located on the back of the machine's cabinet. The ID label shown on next page is for the Model 8000 30-watt product.

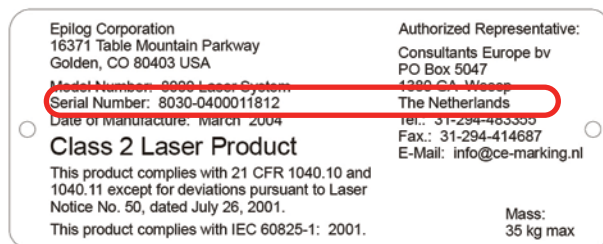

Frequently Asked Questions

Engraver Will Not Vector (Cut)

1. Verify that the print driver is set to Vector or Combined mode.
2. Verify that the lines that you want to vector are set to .001" (0.025 mm).
3. Make sure the images are vector lines. Scanned and raster images will not vector.
4. Filled or solid images will not vector (outlines only).

Engraving Appears Lighter Than Usual

1. All mirrors and lenses need to be cleaned and inspected for damage. See **"Cleaning the Optics"** on page 69 for cleaning instructions.
2. Verify that the lens is in correct focus.
3. Verify correct Speed, Power and Frequency settings for the type of material that you are engraving.

No Laser Beam, But the Engraver Appears to be Running Normally

1. Verify the laser is in focus.
2. Check that the speed and power settings are appropriate.
3. Verify that the door on top of the laser system is tightly closed.

The Exhaust Is Not Pulling Enough Air

1. Move the blower closer to the machine. The closer the two are, the better exhaust you will receive.
2. If you are using a flex hose, do not bundle up the excess. Stretch out the flex hose, cut it to the desired length and use only what you need.
3. Clean your exhaust system on a regular basis, including the engraver and blower. Use a bottle-brush and a vacuum on the areas where the exhaust buildup accumulates.

The Engraving Quality is Poor/Blurry/Double Image

1. If you feel you are not getting quality you once were, this is probably a maintenance issue. See the “**Section : Cleaning & Maintenance**” on page 69.
2. Clean the lenses of the system. See “**Cleaning the Optics**” on page 69 for cleaning instructions.
3. If you are experiencing a double image problem or other quality issue, it is best to run a sample and send a photo to: tech@epiloglaser.com.

The Laser isn't Communicating with My Computer

1. Is the computer's TCP/IP address set to a different number than the IP address of the laser? See “**Set Up TCP/IP Address in the Computer**” on page 26.
2. Is the computer's ethernet connection enabled? Go to the **Network and Sharing Center**, select **Change Adapter Settings**. If the Local Area Connection says Disabled, right click and choose Enable.

LCD Screen Displays “Position Error”

The engraver is informing you that it has lost its correct positioning. Power off the engraver and verify there is nothing obstructing the travel of the carriage both left-to-right and front-to-back. After removing any obstruction, turn the laser back on. Contact Technical Support if there still is an error displayed.

Why Isn't My Red Dot Pointer at the Top Left Corner When Parked?

This is normal - after you have set home, pressing the **Reset** key will move the carriage to its park position approximately 1/2 inch (12 mm) to the front of where you set home. **You do not need to adjust your home position.** See “**Reset Home Position**” on page 83 for more information.

The Engraving Depth Varies on Different Areas of the Engraving Table

The engraving table may not be level. With the laser at the Home Position, use the manual focus gauge to focus the table. Press the **X/Y Off key** on the keypad, then **Go**. Move the carriage to all four corners of the table to see if it is level. If it is not, contact Technical Support at +1 303-215-9171 for instructions on leveling the table.

I'm Installing My Rotary, But Can't Find The Holes For Installation

Don't see the holes? Have you removed the Crumb Tray yet? See "**Integrated Crumb Tray**" on page 89 for instructions on how to remove the tray.

How Can I Increase the Life of my Laser System?

- **Clean your system:** Debris in the laser and on the mechanics of the system can reduce the life of parts in your system. Wipe down your system on a regular schedule to keep the mechanics clean and long lasting.



- **Clean the lenses:** Lens life is greatly increased by keeping them clean and free of debris. Get in the habit of wiping them off on a regular schedule to keep them clean and well maintained.
- **Reduce speed when running very small items:** When you run at 100% speed on a graphic with a very short stroke, the lens assembly comes up to speed and slows down extremely quickly, which can place wear on the mechanics of the laser. Slow down to 80 - 90% speed and increase the lifetime of your laser system.

How to Shorten Your Engraving/Cutting Time

- **Lower the Resolution:** How important is the highest resolution image? Processing jobs at 400 DPI vs. 600 DPI can reduce cycle times by up to 30%, and processing at 300 DPI could mean half the cycle time.
- **Reduce White Space:** Orientate the parts to minimize engraving dead space (area where head travels, but has nothing to engrave).
- **Horizontal Layout:** If an option, horizontal text will engrave faster than vertical or curved (fit text to curve) text.
- **Color Mapping:** Use the Color Mapping feature to save time by adjusting the order in which the objects engrave/mark.
- **Run Multiples:** If you need to engrave multiples of the same image. You'll find you have a time savings per piece.

If these do not correct your issue or your issue is not listed, please contact the Technical Support Team at +1 303-215-9171 or tech@epiloglaser.com.

SECTION 16: MATERIAL SUPPLIERS

Industry Material Supplier List

Industry Material Supplier List

The following list contains supplier information for materials typically used with your Epilog Laser. Additional suppliers and links can be found on our website at http://www.epiloglaser.com/industry_links.htm.

Acrylic

Acrylic Idea Factory

Norcross, GA
800-543-9253
www.acrylicidea.com

E&T Plastics

Blaine, MN
763-780-3700
www.e-tplastics.com

Inventables

Chicago, IL
312-775-7009
www.inventables.com

JDS

Sioux Falls, SD
800-843-8853
www.jdsindustries.com

Polycrylic

Norton, VT
800-809-4217
www.polycrylic.com

RB Fabrication

Orange, CA
714-998-2700
www.rbfabrication.com

U.S. Plastic Corp

Chicago, IL
312-775-7009
www.usplastic.com

Color Fill Materials

JDS

Sioux Falls, SD
800-843-8853
www.jdsindustries.com

Smoke-Wood

Elgin, OR
800-248-2352
www.smoke-wood.com

Corian and Fountainhead

Johnson Plastics Plus

Minneapolis, MN
800-869-7800
www.johnsonplastics.com

Cork

Jelinek Cork Group

Savannah, GA
800-959-0995
www.corkstore.com

Custom Artwork and Graphics

Cascade Metal Designs

Burlington, WA
360-420-5962
www.freedxf.com

Digital Art Solutions

Tempe, AZ 85281
800-959-7627
www.digitalartsolutions.com

Gantry Company (3D Graphics)

Chippewa Falls, WI
715-288-6100
www.gantryco.com

Laser Pattern Werx

Nehalem, OR
503-368-3194
www.etsy.com/shop/laserpatternwerx

Educational Materials

CoreIDRAW Help

Albany, OR
www.coreldrawhelp.com

Fabric

SEF Americas - LaserFlex

Jacksonville, FL
844-720-9600
www.seftextile.com

Twill USA

Aurora, IN
866-806-9120
www.twillusa.com

Webster Fabrics

Chesterfield, MO
800-845-4323
www.websterfabric.com

Glass

DiscountMugs.com

Medley, FL

SECTION 16: MATERIAL SUPPLIERS

Industry Material Supplier List

800-569-1980
www.discountmugs.com
JDS
Sioux Falls, SD
800-843-8853
www.jdsindustries.com

Max Gift International
Beaverton, OR
503-579-9804
www.max-gift.com

Laser Engraveable Products

Johnson Plastics Plus
Minneapolis, MN
800-869-7800
www.johnsonplastics.com

LaserGifts
Prescott, AZ
888-674-6612
www.lasergifts.com

Leather (and Laserable Faux)

JDS
Sioux Falls, SD
800-843-8853
www.jdsindustries.com

Tandy Leather Factory
Forth Worth, TX
877-532-8437
www.tandy-leather.com

Marble

Jon-Ko
San Diego, CA
800-537-9092
www.jon-ko.com

LaserSketch
Romeoville, IL
630-243-6360
www.lasersketch.com
Marble Max
www.max.com

Medals (Engraveable)

Catania
Avon Lake, OH
800-633-2586
www.cataniainc.com

JDS
Sioux Falls, SD
800-843-8853
www.jdsindustries.com

Metal (Engraveable)

AlumaMark
Cleveland, OH
800-482-7758
www.alumamark.com

Identification Plates, Inc.
Mesquite, TX
800-395-2570
www.idplates.com

Inland Products
Riverside, CA
800-481-5500
www.inlandproducts.com

JDS
Sioux Falls, SD
800-843-8853
www.jdsindustries.com

NapTags
Grand Rapids, MI
800-451-3330
www.NapTags.com

R.S. Owens & Company
Chicago, IL
800-282-6200
www.rsowens.com

Victory
Chicago, IL
800-327-5578
www.buyvictory.com

Metal Marking Compounds

CerMark Sales
Multiple Shipping Locations
866-241-9881
cermarksales.com

EnduraMark
Austin, TX
512-236-6424
enduramark.com

Ferro (\$500 minimum order)
Mayfield Heights, OH
800-245-4951
www.ferro.com

JDS
Sioux Falls, SD
800-843-8853
www.jdsindustries.com

Johnson Plastics Plus
Minneapolis, MN
800-869-7800
www.johnsonplastics.com

LaserBond
Los Angeles, CA
844-577-7772
www.laserbondingtech.com

SECTION 16: MATERIAL SUPPLIERS

Industry Material Supplier List

Mother of Pearl

Duke of Pearl

Lusby, MD
410-231-2641
www.dukeofpearl.com

Aqua Blue Maui, LLC

Kula, HI
808-876-0217
www.aquablumaiui.com

Pen and Pencil Sets

IMARK Pen Co.

Arlington, TX
817-385-0306
www.IMARK-Pen.com

JDS

Sioux Falls, SD
800-843-8853
www.jdsindustries.com

Plastics (Engraveable)

Colorado Plastic Products

Lakewood, CO
303-443-9271
www.coloradoplastics.com

Innovative Plastics

Algonquin, IL
815-477-0778
www.inoplas.com

JDS

Sioux Falls, SD
800-843-8853
www.jdsindustries.com

Johnson Plastics Plus

Minneapolis, MN
800-869-7800
www.johnsonplastics.com

Rowmark

Findlay, OH
800-243-3339
www.rowmark.com

Southeast Plastics

866-491-9044
www.southeastplastics.com

Plaques & Trophies

JDS

Sioux Falls, SD
800-843-8853
www.jdsindustries.com

Marble Trophies of SD

South Dakota
619-422-8298
www.marbletrophiesofsd.com/

Slate

Laser Slate

866-491-9044
www.laserslate.com

Sports Materials

JDS

Sioux Falls, SD
800-843-8853
www.jdsindustries.com

MiniSticks

Buffalo, NY
866-646-4784
www.ministicks.com

Tapes and Foils

Innotech of Wisconsin

Racine, WI
800-776-7194
www.innotape.com

JDS

Sioux Falls, SD
800-843-8853
www.jdsindustries.com

Polyonics

Westmoreland, NH
603-352-1415
www.polyonics.com

Taskboard

Taskboard

Miami, FL
561-983-6289
www.taskboard.com

Wood: Plaques and Specialty Products

Colorado Heirloom

Loveland, CO
970-667-4222
www.coloradoheirloom.com

Infinity Woods

Clarion, PA
814-226-4361
www.infinitywoods.com

JDS

Sioux Falls, SD
800-843-8853
www.jdsindustries.com

Lasers & Woodworking

Cumberland, MD
301-777-0250
www.lasersandwoodworking.com

Lazer Depot

Mason, IL
217-663-2708
www.thelazerdepot.com

SECTION 16: MATERIAL SUPPLIERS

Industry Material Supplier List

Lee's Wood Products

Rocky Mount, VA
800-552-5337
www.leeswoodproducts.com

Stanton Mfg. Co. Inc.

Lake Ozark, MO
573-365-2441
www.stantonmfg.com/

Totally Bamboo

San Marcos, CA
760-471-6600
www.totallybamboo.com

WDI Custom Wood Products

Forest Lake, MN
800-899-4265
www.wdicustomwood.com

APPENDIX A: WARRANTY STATEMENT

Warranty Statement for the Epilog Mini/Helix Laser

Warranty Statement for the Epilog Mini/Helix Laser

Epilog Corporation warrants to the original purchaser of Epilog Model 8000 that this product will be free from defects in material or workmanship when purchased, and under proper, normal use within two (2) years from the original date of purchase.

Epilog will replace or, at its option, repair the defective part(s). Normally, Epilog will supply a replacement part for the customer to replace. Once the replacement has been performed, the replaced part must be returned to Epilog. In the case where repair is required, Epilog requires that the defective part, or machine, be returned to the Epilog factory or other Epilog designated facility. Epilog will be responsible solely for the cost of repairs, including parts and labor, which are made at an authorized Epilog facility. All other costs for replacement or repair, including, but not limited to, packaging and shipping both to and from Epilog, shall be paid by the owner. A "Core" charge may be required by Epilog to ensure the return of replacement and repair parts. This warranty excludes any damage from abuse (including, without limitation, incorrect voltages, power surges, fires, improper or insufficient ventilation "acts of God" or other situations out of the control of Epilog), failure to operate in accordance with instructions provided in the Owner's Manuals for the Epilog models 8000, including specific safety and operational warnings contained therein, cosmetic damage sustained in use, and damage caused by unauthorized modifications of any equipment. All warranties to original purchasers are non-transferable. The registered owner must initiate warranty claims within the warranty period.

THE ABOVE AND FOREGOING IS THE ONLY WARRANTY OF ANY KIND, EITHER EXPRESS OR IMPLIED; INCLUDING BUT NOT LIMITED TO ANY WARRANTIES OF MERCHANTABILITY AND FITNESS FOR A PARTICULAR PURPOSE, THAT ARE MADE BY EPILOG ON MODEL 8000. ANY WARRANTIES IMPLIED BY LAW ARE HEREBY EXPRESSLY DISCLAIMED.

No oral or written information or advice given by Epilog, its dealers, its distributors, agents, officers, or employees shall create a warranty or in any way increase the scope of this warranty. Neither Epilog nor anyone else who has been involved in the creation, production, or delivery of the Epilog Model 8000 shall be liable for any direct, indirect, consequential, or incidental damages, including but not limited to damages for loss of business profits, business interruption, loss of business information, adverse health impacts, fire, and the like, arising out of the use or inability to use these products.

Epilog Corporation provides no warranties whatsoever on any software used in connection with Epilog Model 8000.

APPENDIX B: MATERIAL SETTINGS

Epilog Mini / Helix Suggested Material Settings

Epilog Mini / Helix Suggested Material Settings						
Material	DPI/Freq.	30 watt	40 watt	50 watt	60 watt	80 watt
Acrylic						
Photo Engraving	300 DPI	90s 60p	90s 55p	90s 50p	90s 45p	90s 40p
Text/Clipart Engraving	300 DPI	90s 80p	90s 75p	90s 70p	90s 65p	90s 60p
Text/Clipart Engraving	600 DPI	90s 75p	90s 70p	90s 65p	90s 60p	90s 55p
Cutting 1/8" (3 mm)	5000 f	9s 100p	12s 100p	15s 100p	20s 100p	25s 100p
Cutting 1/4" (6 mm)	5000 f	5s 100p	6s 100p	8s 100p	12s 100p	15s 100p
Cutting 3/8" (9.5 mm)	5000 f	-	-	3s 100p	4s 100p	5s 100p
Cutting Note: Adjusting the standard focus distance so it is closer to the lens by about .030" (.762 mm) will produce better edge quality on 1/4" acrylic and thicker. Two passes may produce better results and allow for cutting through thicker materials. There are two types of acrylic: cast is better for engraving (creates a frosted look when engraved) and extruded acrylics are better for smooth-edged cutting.						
Alumamark						
Engraving	300 DPI	90s 55p	90s 45p	90s 35p	90s 25p	90s 20p
Engraving	600 DPI	90s 45p	90s 35p	90s 25p	90s 15p	90s 10p
Anodized Aluminum						
Photos/Clipart	300 DPI	90s 55p	90s 50p	90s 45p	90s 40p	90s 35p
Photos/Clipart	600 DPI	90s 50p	90s 45p	90s 40p	90s 35p	90s 30p
Text	600 DPI	90s 60p	90s 55p	90s 50p	90s 45p	90s 40p
We find when engraving anodized aluminum, text appears best at 600 DPI, but photos and clipart can be engraved with great detail down to 300 DPI.						
Cork						
Engraving	300 DPI	90s 50p	90s 45p	90s 40p	90s 35p	90s 30p
Cutting	500 f	25s 50p	25s 45p	25s 40p	25s 35p	25s 30p
Cotton						
Engraving	300 DPI	90s 30p	90s 25p	90s 20p	90s 15p	90s 10p
Denim						
Engraving	300 DPI	90s 35p	90s 30p	90s 25p	90s 20p	90s 15p
Fleece						
Engraving	150 DPI	90s 35p	90s 30p	90s 25p	90s 20p	90s 15p
Cutting	2500 f	25s 25p	25s 20p	25s 15p	25s 10p	25s 5p
When engraving fabric, try changing the graphic to 80% gray and use the Jarvis dithering pattern for the best results. Every fabric you are cutting will need to have adjusted settings - find a small swatch of the fabric you can test first.						
Glass						
Engraving	300 DPI	15s 100p	20s 100p	25s 100p	30s 100p	35s 100p
When etching glass, try changing the graphic to 80% gray before engraving and using the Jarvis dithering pattern. You can also diffuse heat by covering the glass with a thin sheet of dish soap.						
Leather						
Photo Engraving	300 DPI	90s 40p	90s 35p	90s 30p	90s 25p	90s 20p
Text/Clipart Engraving	600 DPI	90s 50p	90s 45p	90s 40p	90s 35p	90s 30p
Cutting 1/8" (3 mm)	500 f	30s 80p	30s 75p	30s 70p	30s 65p	30s 60p

APPENDIX B: MATERIAL SETTINGS

Epilog Mini / Helix Suggested Material Settings

Epilog Mini / Helix Suggested Material Settings

Material	DPI/Freq.	30 watt	40 watt	50 watt	60 watt	80 watt
Mat Board						
Engraving	400 DPI	70s 100p	70s 90p	70s 80p	70s 70p	70s 60p
Cutting	500 f	20s 50p	20s 45p	20s 40p	20s 35p	20s 30p
Bottom-up engraving is suggested for mat board etching.						
Marble						
Photo Engraving	300 DPI	90s 55p	90s 50p	90s 45p	90s 40p	90s 35p
Text Engraving	600 DPI	90s 65p	90s 60p	90s 55p	90s 50p	90s 45p
Every marble is very different for settings. Start low and increase the power with a second run if you haven't used that marble before.						
Painted Brass						
Engraving	300 DPI	90s 45p	90s 40p	90s 35p	90s 30p	90s 25p
Engraving	600 DPI	90s 40p	90s 35p	90s 30p	90s 25p	90s 20p
Plastics						
Engraving	300 DPI	90s 40p	90s 35p	90s 30p	90s 25p	90s 20p
These settings work well with many plastics, including plastic phones and covers. Even one color plastics can achieve a great look when engraved.						
Plastic (2 Layer Engraveable)						
Engraving	300 DPI	90s 80p	90s 75p	90s 70p	90s 65p	90s 60p
Engraving	600 DPI	90s 70p	90s 65p	90s 60p	90s 55p	90s 50p
Cutting 1/8" (3 mm)	5000 f	15s 100p	20s 100p	30s 100p	30s 85p	30s 70p
Rubber Stamps						
Engraving	400 DPI	6s 100p	10s 100p	20s 100p	30s 100p	50s 100p
Engraving	600 DPI	16s 100p	20s 100p	30s 100p	40s 100p	60s 100p
Cutting	100 f	10s 100p	15s 100p	20s 100p	25s 100p	40s 100p
Stainless Steel w/Cermark						
Engraving	600 DPI	20s 100p	25s 100p	30s 100p	35s 100p	45s 100p
Twill						
Cutting	2500 f	50s 50p	50s 45p	50s 40p	50s 35p	50s 25p
Wood						
Photo Engraving	600 DPI	40s 100p	45s 100p	50s 100p	55s 100p	60s 100p
Clipart/Text Engraving	600 DPI	30s 100p	35s 100p	40s 100p	45s 100p	50s 100p
Clipart/Text Engraving	300 DPI	25s 100p	30s 100p	35s 100p	40s 100p	45s 100p
Deep Engraving	600 DPI	10s 100p	15s 100p	20s 100p	25s 100p	30s 100p
Thin Veneer	500 f	30s 22p	30s 18p	30s 14p	30s 12p	30s 9p
Cutting 1/8" (3 mm)	500 f	25s 100p	30s 100p	35s 100p	40s 100p	45s 100p
Cutting 1/4" (6 mm)	500 f	8s 100p	10s 100p	15s 100p	20s 100p	25s 100p
Cutting 3/8" (9.5 mm)	500 f	-	-	6s 100p	10s 100p	12s 100p
When cutting wood, multiple passes may allow cutting of thicker materials. You can readjust the focus between passes down to the center point of the cut for the best results.						

APPENDIX B: MATERIAL SETTINGS

Epilog Mini / Helix Suggested Material Settings

- **These are only suggestions:** Every type of material will react differently with the laser, even from one plastic to the next. But don't feel that you need to be exact on any of the settings. While engraving acrylic at 35% speed and 75% speed will give you a very different result, the difference between 35% and 39% will be much more subtle and relies more on personal preferences.
- **Test your material:** If you have a small area of the material you won't be using, or an extra of the item, take advantage of this area to test out your settings by engraving a small square or cutting a small circle. You can fine tune your settings in these areas.
- **Similar materials use similar settings:** When you are working with a material you aren't familiar with, think about a similar material and what settings you would use with that product. Most anodized aluminums will react well with similar settings, as will most plastics.
- **When in doubt, start low:** Remember, you can always re-run your job as long as you don't move it in the machine. Let's say you're running a photograph in a one-of-a-kind wood plaque. Start with a lower power setting, look at the engraving, then run the project a second time at high speed and lower power a second time to add a little more depth if needed.
- **Run only one part of the file:** If running a job on a new material, you can always just select one piece of the engraving, like a piece of text, and run that part first to make sure your settings are perfect before running the whole file.



To print a copy of these settings to keep next to your laser, go to www.epiloglaser.com/material-settings.

INDEX

Index

Symbols

3D Engraving 49, 113
10/100 Network Interface Card 130
21 CFR 1040 6
21 CFR 1040.10 3
21 CFR 1040.11 3
32-bit Operating System 130
64-bit Operating System 130

A

Acrylic 114–115
 Cast Acrylic 114
 Cutting 115
 Engraving 114
 Extruded Acrylic 114
 Type of Acrylic 114
Activating a Laser 38
Advanced Tab 49
Air Assist 75
 Acrylic Cutting 115
 Color Mapping 51
 Fire Warning 1
 Plastic Cutting 120
 Wood Cutting 125
Air-Cooled 12, 129
Air Filter. *See* Exhaust Fan
Air Temperature 12
Alder 124
Alumamark 143
Anodized Aluminum 143
 Black 115
 Red 116
ANSI 4
Artwork Layout 97
AutoCAD 111–112
Auto Delete 56
Auto Focus 76

B

Bearing Rail 72
 Lubrication 72
Bearings 72–73, 129
 X-Axis Rail 72
 Y-Axis Rail 72
Belts 129
Blower. *See* Exhaust Fan
Brass

Brass-Coated Steel 116
Painted 116–127
Solid 116

C

Center Engraving 85–87
 Center-Center 85
 Center-Left 86
 Center-Top 86
 Page-Center 86
Cermark 144
Cherry 124
Class A 132
Cleaning and Maintenance 69–74
 Bearing Rails 71
 Crumb Tray 73
 Down Draft Ports 74
 Laser Tube 74
 Optics 69
 Rear Exhaust Port 74
 Y-Axis Rail 72
CO2 Laser Source 131
Color Fill 126
Color Mapping
 Combined Mode 83
 Functions 80
 Non-Mapped Colors 82
 Object Order 82
 Speed and Power 80
Color Mapping Tab 51
Computer Recommendation 130
Config Button 56
Configurations 50
Cooling Requirements 12
CoreIDRAW Help 137
Corian Supplier 137
Cork
 Settings 143
 Suppliers 137
Create a Cut Line 63

D

Data Transfer Light 55
Delete Job Button 58
Delrin 118
Dish Soap 118
Dithering 48, 77, 117
 Floyd-Steinberg 78
 Jarvis 78
 Photograph Modes 78
 Stucki 78

INDEX

Door Interlocks
 Interlock Safety 6
Down-Draft Ports 74
Drive Wheel 97

E

Electrical Requirements 14, 129
Electrical Safety 4
Engraving Direction
 Bottom-Top 48
Engraving Techniques 113–127
Epilog Job Manager
 Activate a Laser 38
 Color Mapping 43
 Defaults 45
 Installation 35
 Instructions 35, 38
 Organizing Your Print Jobs 39
 Previewing Your Job 41
 Printing 39
 Print to Job Manager 47
 Program Settings 43
 Trouble Shooting 37
Ethernet
 Specifications 129
 Window 8/10 Installation 26
 Windows 7 Installation 19
Exhaust Fan 12
 Connection 12

F

FCC 132
Federal Communications Commission 132
Fire Extinguisher
 Halotron 1
Fire Warning 1, 5
Firmware
 Driver Location 50
 Upgrading 109–110
Focus
 Auto Focus 76
 Auto vs. Manual Focus 75
 Manual Focus 75
Focus Button 59
Frequency 48
 Color Mapping 51

G

General Tab 46
Glass 117–127, 143

Engraving 117
 Suppliers 137
Go Button 54
Grayscale 117, 125

H

Hard Drive 131

I

IEC 60825-1 6
Installing Firmware 109. *See* Firmware
Interlock Safety 6
IP Address
 Setup in the Computer 19
 Setup in the Laser 15

J

Jarvis 117
Job Delete Button 58
Job Manager. *See* Epilog Job Manager
Job Save Button 58
Jobs List Button 58
Job Storage 59
Job Type 46

L

Landscape vs Portrait 66
Laserable Plastics
 Engraving Techniques 119
LaserBrite™ 116
Laser Dashboard
 Advanced Tab 49
 Color Mapping Tab 51
 Defaults 45
 General Tab 46
 Settings and Use 45–52
Laser Safety 3
Laser System Classification 129
Laser Tube 74
Leather 138, 143
Lens
 Cleaning 69

M

Maintenance 69. *See* Cleaning and Maintenance
 Maintenance Button 56
Manual Focus 75
Manufactured Wood Products 125
Maple 124

INDEX

Marble 144
Marble Suppliers 138
Masking 118, 120, 126
Material Settings 143
Material Supplier List 137
Maximum Engraving Area 129
Max Material Thickness 129
MDF 125
Medals (Engraveable) Suppliers 137
Memory Buffer 129
Mirror 50
 Cleaning 69
Motion Control System 129
Movable Home Position 84
Multiple Pages 52
Multiple Passes 52

N

Notary Seals 118

O

Oak 124
Object Order 82
Open Architecture 130
Operating Modes 129
Operating System 130
Operating Temperature 12
Optics
 Cleaning 69–70
Organizing Print Jobs 39
OSHA 4

P

Page-Center Engraving 86
Painted Brass 116, 117, 144
Paper/Pressboard Suppliers 139
Pause Button 54
Pen and Pencil Set Suppliers 139
Photo Engraving 61, 77, 144
Photograph Modes 78
PhotoLaser Plus 101, 131
 Badge Creation 105
 Material Selection 103
 Photograph Transformation 102
 Setting Resolution 103
 Setting Up 101
 Using with CorelDRAW 103
Piece Size 47
Pin Table 91–93, 115
Plastic 119–127, 144

Cutting 120
 Engraveable 144
 Engraving 119
Plastic (Engraveable) Suppliers 139
Plotting 111
Plywood 125
Pointer Button 55
Polish 118
Polyvinyl Chloride 9, 120
Portrait vs Landscape 66
Power
 Connection 14
 Laser Dashboard 47
Power Change Button 57
Previewing Your Job 41
Print Driver. *See* Laser Dashboard
Print Interface 129
Print Range 52
Processor Speed 130
PVC 9, 120

R

RAM 130
Raster Settings 47
Raster Type 49
Red Dot Pointer 6, 83
 Button 55
Reducing Engraving Time 66
Regulatory Compliance 6–9
Reset Button 54
Reset Home Position 83
 Button 55
Resolution 129
 When to Use Each 63
Restore Home Position 55, 83
Rotary Attachment
 Holes for Installation 136
 Standard Rim-Drive Rotary Attachment 94–100
 Adjusting Your Artwork 98
 Artwork Layout 97
 Drive Wheel 97
 Installation 94
 Removal 100
Rubber Stamps 144

S

Safety Enclosure 6
Safety Features 6–9
Safety Labels 6
Sandblasting 118
Save Job Permanently

INDEX

- Button 58
- Serial Number 133
- Set Home Button 54
- Set the Computer's IP Address 19, 26
- Set the Laser's IP Address 15
- Setting a New Home Position 83
- Setting a Vector Cutting Line 63
- Setting Home Position 54
- Settings Button 56
- Shoulders 50
- Slate Suppliers 139
- Software 131
- Speed and Power Control 129
- Speed Change Button 57
- Sports Material Suppliers 139
- Stainless Steel 144
- Stamp
 - Settings 50
 - Stamp Match 56
 - Stamp Mode 49
- Standard Features 129
- Stretching Artwork 98
- Supplier List 137
- Surge Protector 131

T

- Task Plate 87
- TCP/IP Address Setup in the Computer 19
- Technical Specifications 129
- Technical Support 133
- Temperature 12
- Temporary Memory 59
- Test Port 15
- Test Your Material 145
- Thin Veneer 144

U

- Unpacking the Laser 11
- Upgrading Firmware. *See* Firmware
- USB
 - Windows 7 Installation 23
 - Windows 8 Installation 30

V

- Vector Cutting Table 88
 - Acrylic 115
 - Fire Warning 69
 - Plastics 120
 - Wood 125
- Vector Line Creation 63

- Vector Settings 48
- Vent Cleaning 73
- Ventilation 129
- Vinyl 9
- Voltage 14

W

- Walnut 124
- Warning Labels 6
- Warranty 141
- Wattages 129
- Wavelength
 - CO2 Laser Source 131
- Weight 129
- Widening 50
- Windows 7
 - Ethernet Installation 19
 - USB Installation 30
- Windows 8
 - Ethernet Installation 26
 - USB Installation 30
- Windows 10
 - Ethernet Installation 24
 - USB Installation 30
- Wood 124–127, 144
 - Bare Wood 124
 - Cleaning 126
 - Cutting 125
 - Engraving 125
 - Grain 124
 - Solid 124, 125
 - Specialty Product Suppliers 139
 - Stained 124

Y

- Y-Axis Rail 72